

ALUFIX Basic Sets

Catalogue 2016^{E07}

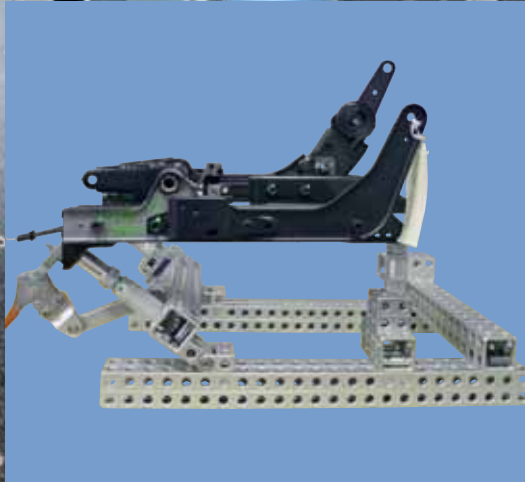

Modular Clamping Systems

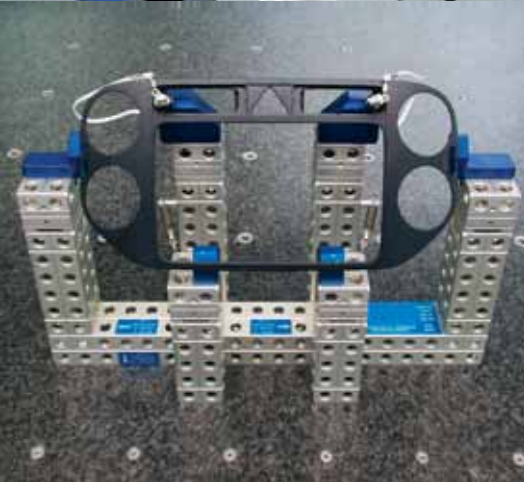
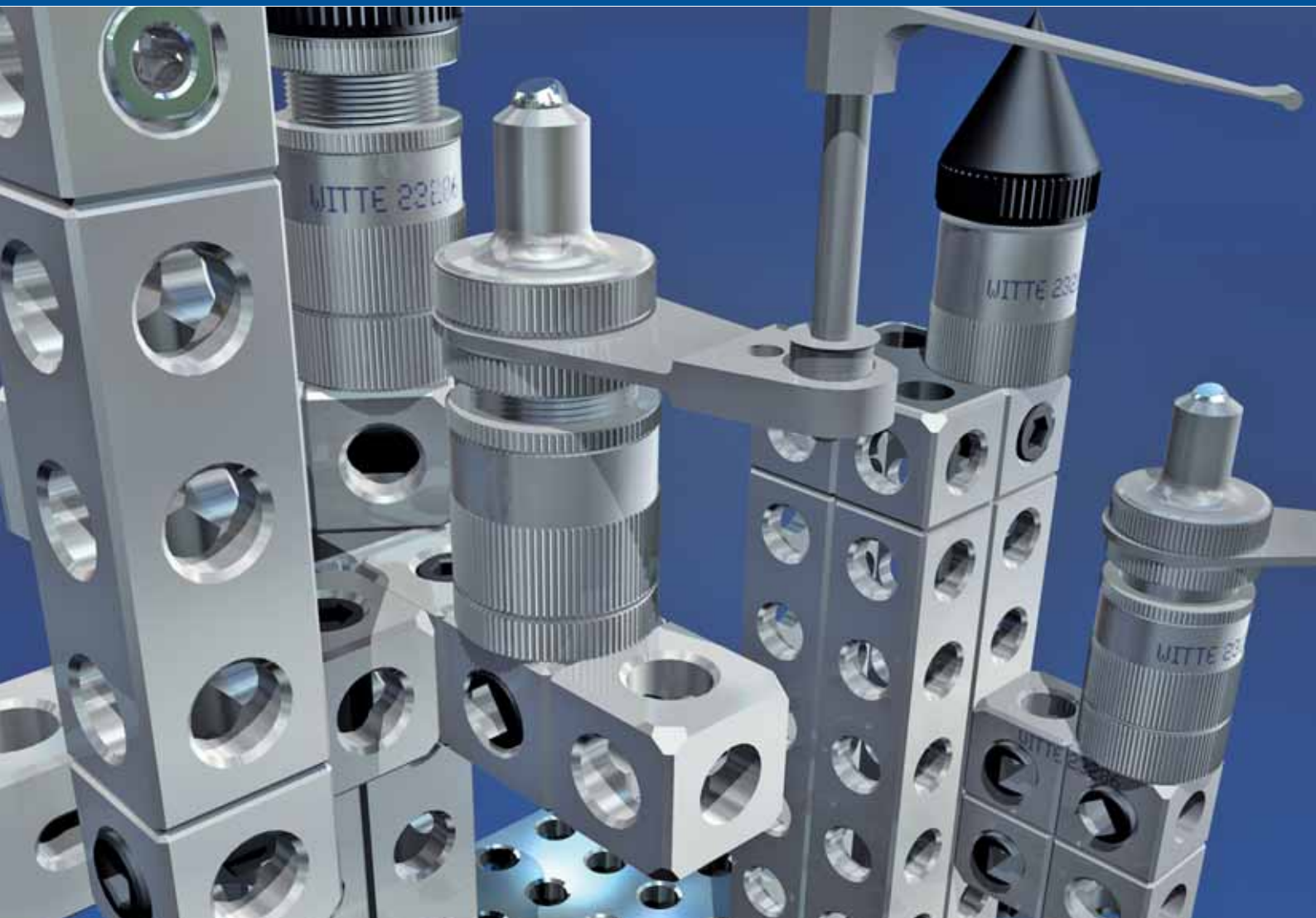



Hightech in Aluminium

Witte was founded in 1969 and initially manufactured complex, high-precision parts for the aerospace industry. Today Witte has developed into a leading manufacturer of fixturing systems and gauges for all kinds of applications.

Almost all major companies from automotive and aircraft industries rely on Witte products and their experience of over 45 years.





Starter Kits4
 ■ Fast clamping with ALUFIX

Basic Set6
 ■ Clamp accessory kit for measuring machines

Basic Set AF 167
 ■ 75-pcs

Basic Set 19
 ■ Alufix 25 ■ 67-pcs

Basic Set 210
 ■ Alufix 25 ■ 103-pcs

Basic Set 312
 ■ Alufix 25 ■ 105-pcs

Basic Set 414
 ■ Alufix 25 ■ 228-pcs

Basic Set 516
 ■ Alufix 25 ■ 344-pcs

Basic Set 618
 ■ Alufix 25 ■ 332-pcs

Basic Set 720
 ■ Alufix 25 ■ 418-pcs

Basic Set 922
 ■ Alufix 25 ■ 434-pcs

Extension Set 124
 ■ Alufix 25 ■ 97-pcs

Extension Set 225
 ■ Alufix 25 ■ 143-pcs

Extension Set 326
 ■ Alufix 25 ■ 209-pcs

Workstations27
 ■ Metal ■ With or without Storage compartment



Certification

Witte Barskamp KG is certified according to

- DIN EN ISO 9001
- DIN EN ISO 9100
- QSF-A (Aerospace suppliers)

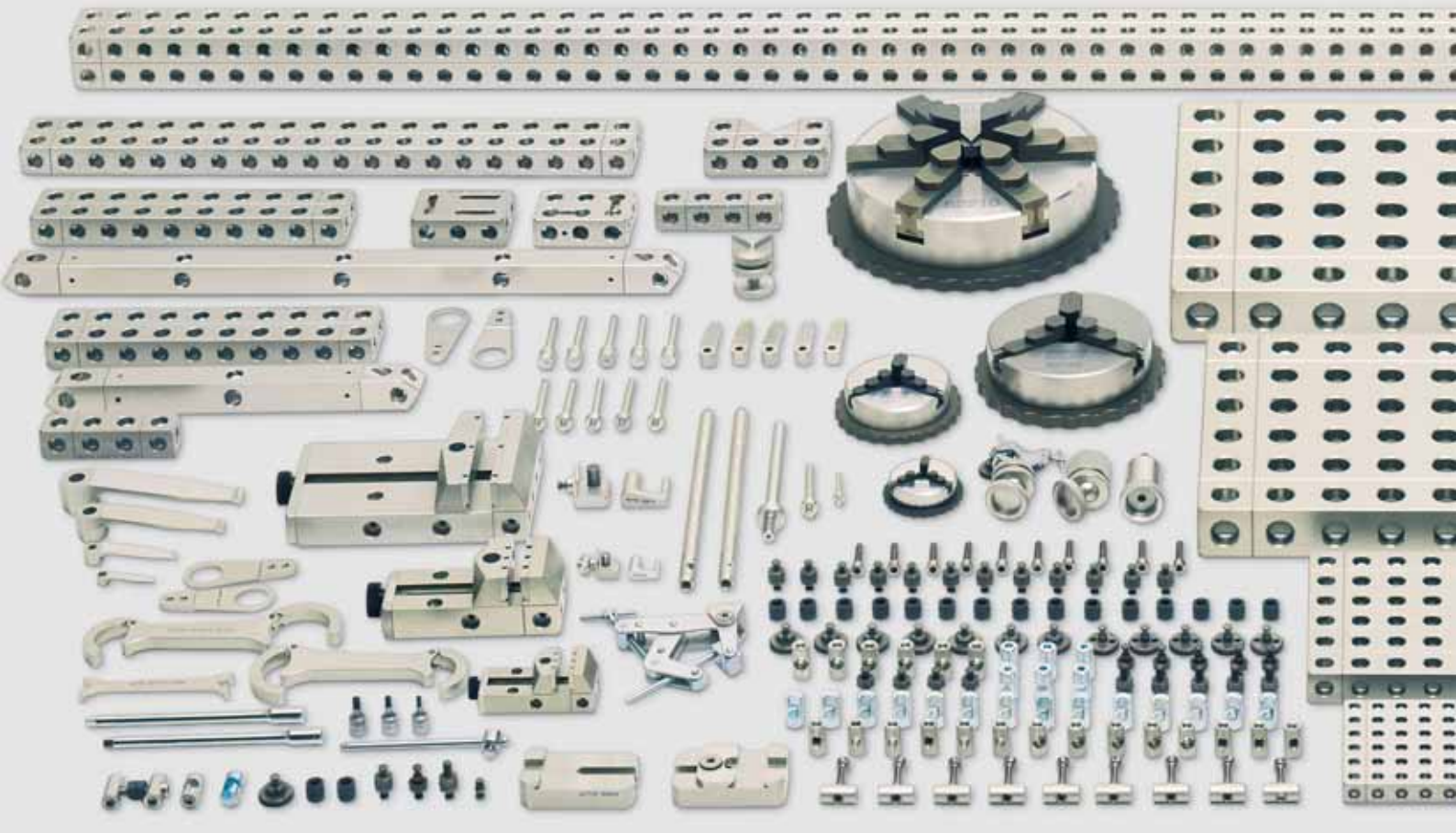

Components

ALUFIX CLASSIC

Alufix Classic is the worldwide renowned and proven modular clamping and fixturing system for almost all applications in dimensional measuring technology. Due to the high accuracy and quantity of intelligent elements Alufix sets are also in use as assembly and positioning systems.

Right across all business areas ranging from automotive industry through aerospace to biomedical sciences people trust and use Witte Alufix Classic. If you have different materials, your parts vary in size, mass or stability, or you are measuring with tactile or optical equipment, Alufix Classic is the answer!

Due to the variety of components and of course the long experience of Witte Alufix Classic offers a solution for almost every task.

Alufix Classic is not only an investment for current requirements but especially for the future, as all elements, according to the real idea of a modular system, are reusable and compatible with other Witte systems and elements.



Base plates

serve as a base for building small to medium size fixtures. They can be connected on all 6 sides using quick or screw connection technology and are extremely flexible for all kinds of applications.



Bars

are suitable for building small to medium size fixtures as a link between base and workpiece contact point. They can be connected on all 6 sides using quick or screw connection technology and are extremely flexible for all kinds of applications.

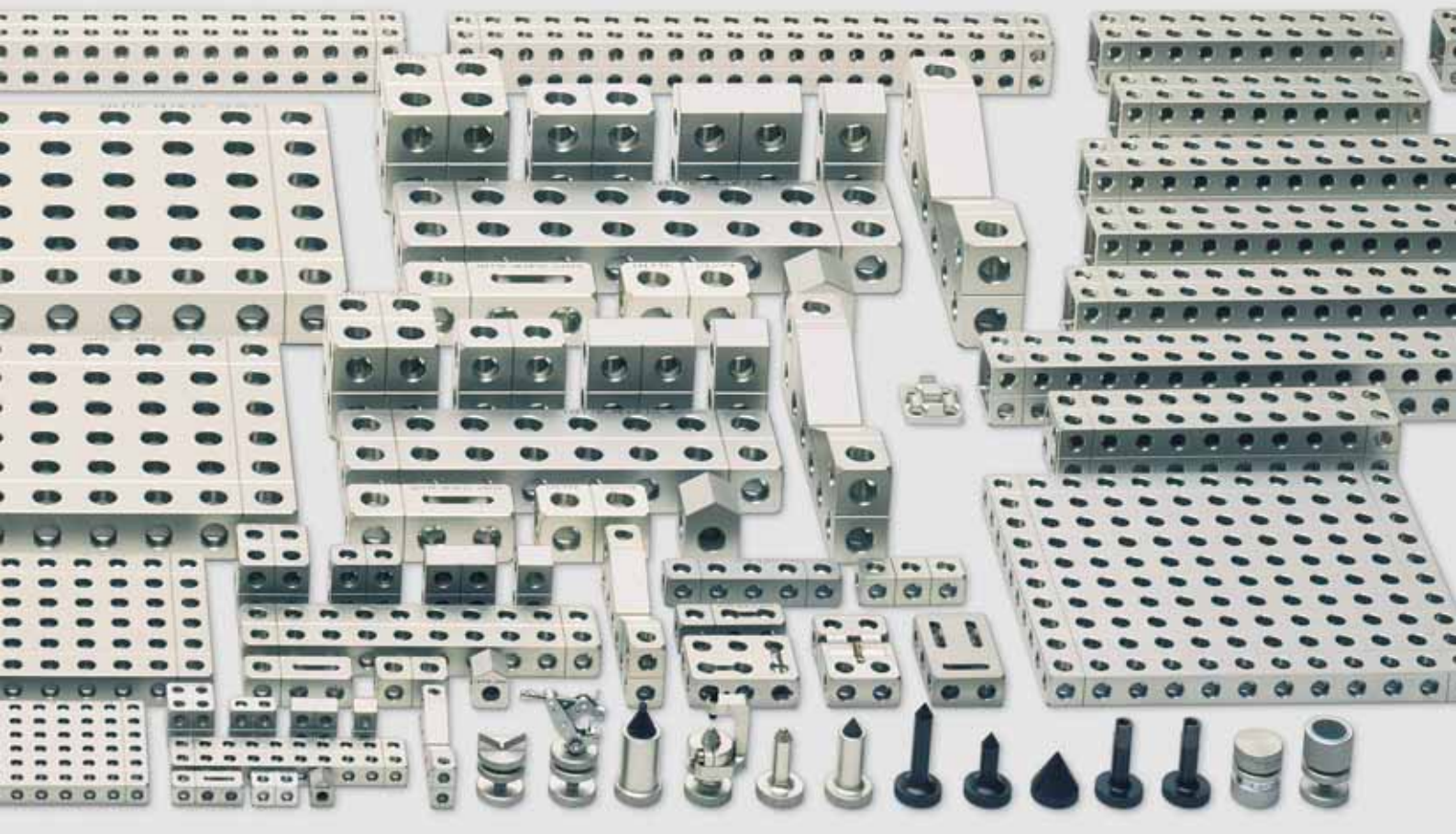
Top sections

provide the contact between workpiece and Alufix fixture. Reliable grid or off-grid positioning is possible with ball joints, screw-jacks and extensions available in many variations.

Struts

serve to increase rigidity in frame type fixtures and for supporting columns. Depending on requirements they are connected at the ends to bars, grid or base plates using quick or screw connectors. The specially designed strut ends allow them to be mounted in two different angles by rotating 180°.

Clamping elements

and clamps also in combination with workpiece contact points

Adjustment elements

enable contact points to be accurately aligned with a workpiece independent of the system grid.

ALUFIX CLASSIC Starter Kits

Fast clamping with ALUFIX

STARTER KIT

A



#83131

Screw clamp

with ball joint and foot plate, 371g

- max clamping width 25 mm
- extension 100 mm

STARTER KIT

B

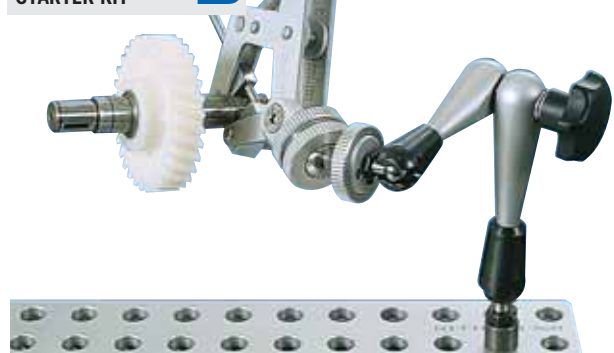

#83132

Screw clamp

with ball joint, swivel arm and screw clamp, 936g

- max clamping width 50 mm
- arm length 280 mm (2x140)
- hydraulic central clamping
- workpiece can be fixed in any position

STARTER KIT

C



#81020

Clamping element set

M6, 69 Pcs, 650g

Comprising:

- 20 clamps in different shapes and lengths from 45 to 85mm
- 24 threaded rods M6 in 6 lengths from 25 to 150mm
- 4 coupling nuts, 10 knurled nuts and 10 washers

STARTER KIT

D



#83134

Hold down spring

and hold down stud with M6 thread, 40g

Comprising:

- Hold down spring L=60mm
- Hold down stud L=60mm (other length on request)
- One reducer sleeve each with thread M8, M10 und M12

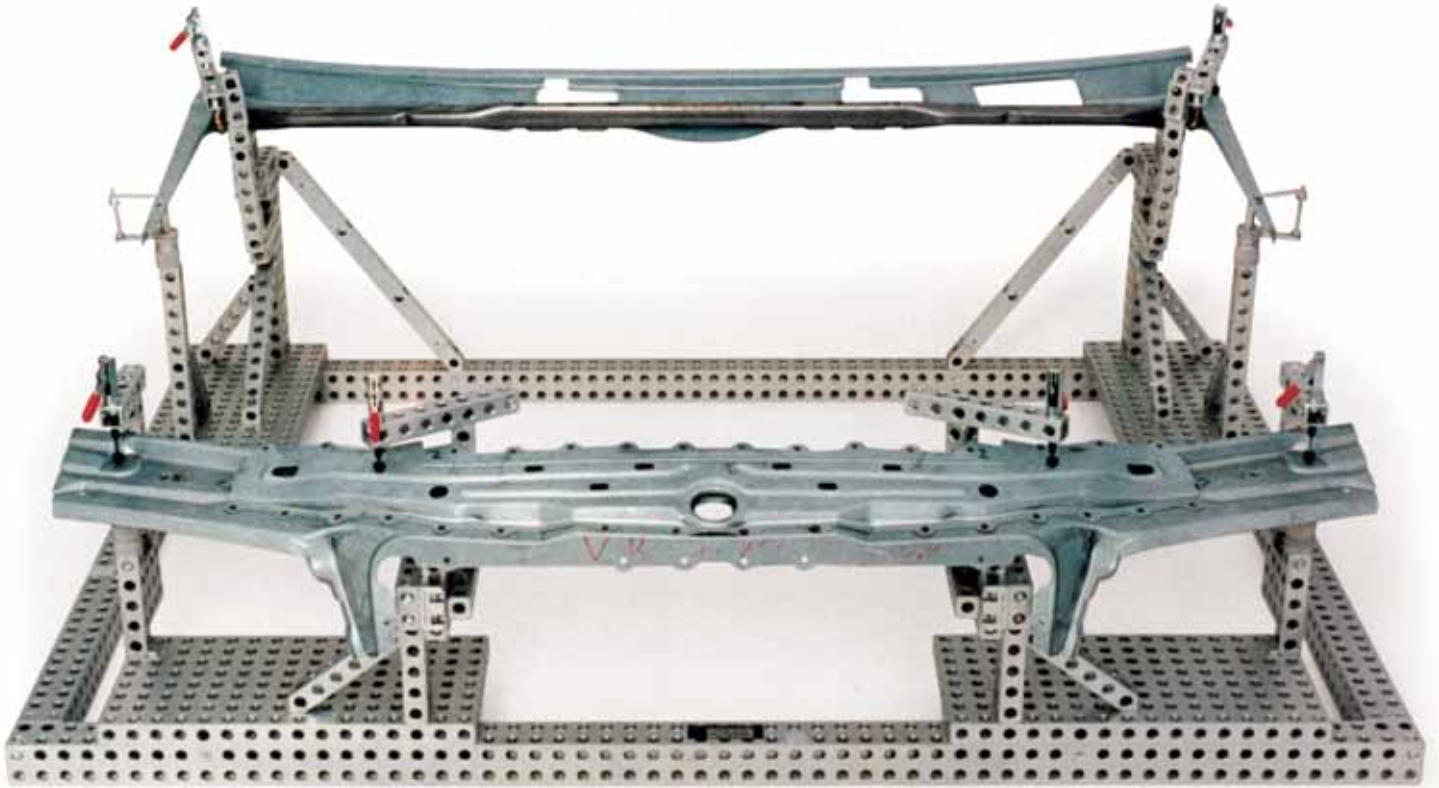
STARTER KIT
E

#83135
Vise
with pins, jaw width 50 mm, 510g

- high tensile aluminium
- exchangeable jaws
- clamping width 65 mm
- optional accessories
- jaw width available from 32 up to 160 mm

STARTER KIT
F

#82080
Keyless chuck
with reversible jaws, D80, 386g

- high tensile aluminium
- centric clamping
- 3- or 6-jaw version
- optional accessories
- 6 models with diameters from 50 to 200mm



ALUFIX CLASSIC elements can be anodized in different colours. The colour natural is standard, black (-1) is available as an alternative. Other colours on request.

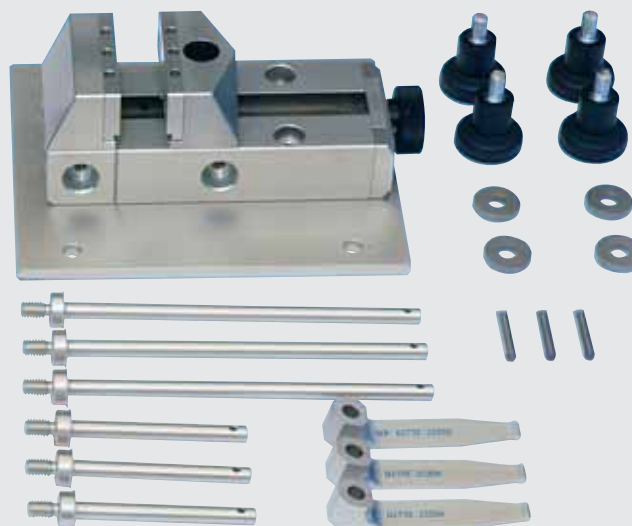
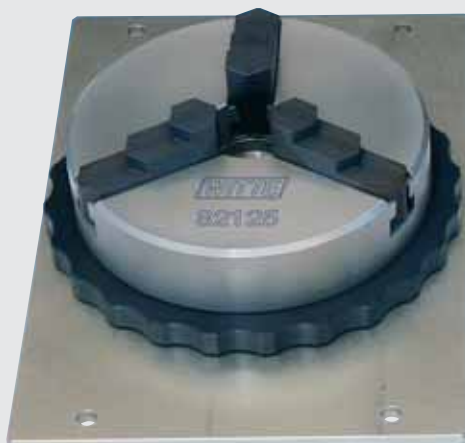

STARTER KIT



#96092 Basic Set

Clamp accessory kit for measuring machines
(23-pcs), 9,8 kg

Nr.	Qty.	Name
96106	1	Keyless chuck $\varnothing 125$, 3 jaws
96107	1	Vise 50 AF25
24605	3	Pin for vise AF25
22258	3	Hod down spring
54766	3	Hold down stud AF25
54767	3	Hold down stud AF25
13086	4	Screw with knurled grip
21286	4	Washer $\varnothing 6,4$
96315	1	Storage box with inlay

 Keyless chuck and vise mounted on aluminium plate



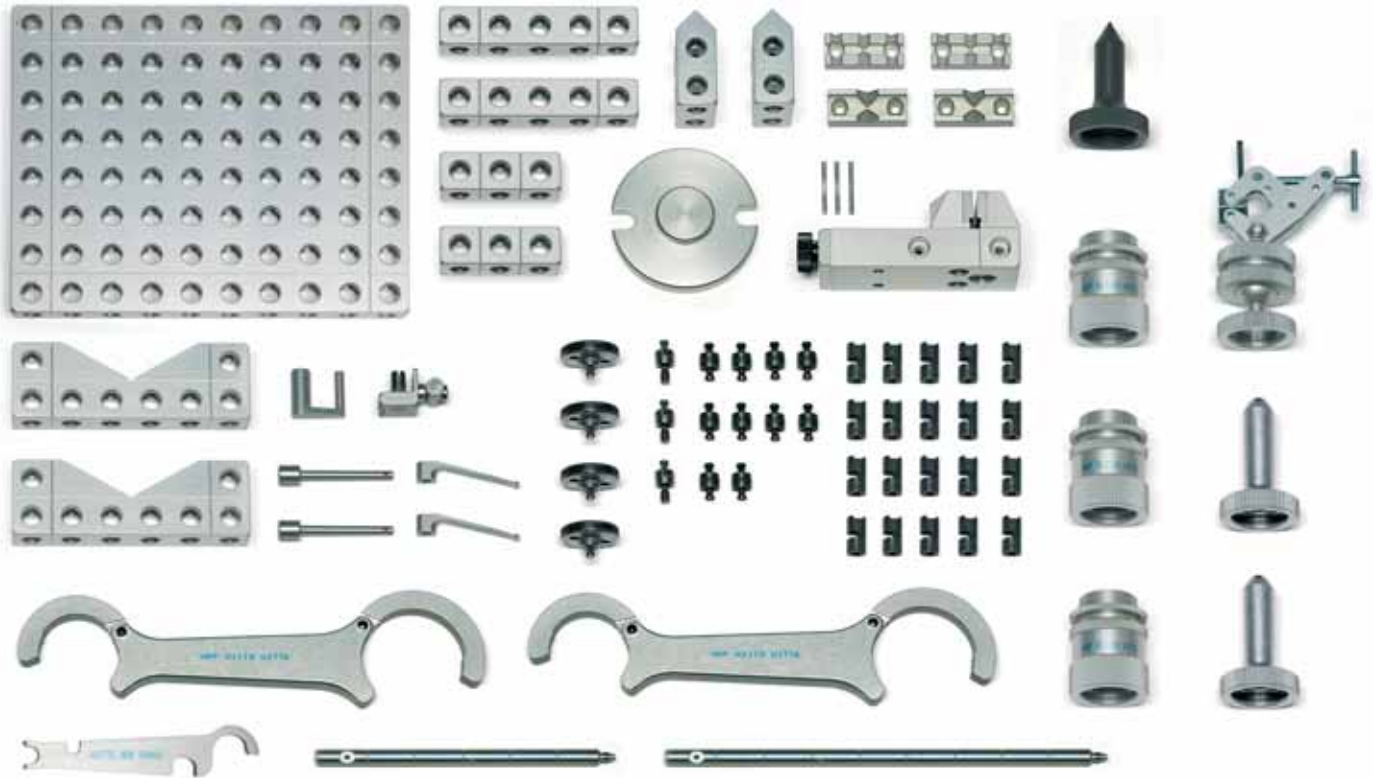

#90271 Basic Set

Alufix 16, medium (75-pcs), 2,3 kg

Nr.	Qty.	Name
21573	1	Base plate 16x96x160
21586	2	Bar 16x16x80
21584	2	Bar 16x16x48
22173	2	V Block 90°
82672	1	Quick connector set (36-pcs)
81492	1	Tools (4-pcs)
82139	3	Screw-jack h38-50
23252	1	Bolt disk with stud
21670	1	Universal plate

Nr.	Qty.	Name
21646	1	Center, long
80584	2	Center with ball
21988	2	V piece 120°
80925	1	Screw clamp w ball joint
80742	1	Winder
22274	1	Deflector
20244	2	Hold down spring
20338	2	Hold down stud
81790	1	Vise set with flat and V jaws (11-pcs)



ALUFIX CLASSIC elements can be anodized in different colours. The colour natural is standard, black (-1) is available as an alternative. Other colours on request.



ALUFIXCOLOR

All Alufix basic sets are also available anodized black for use with tactile measuring systems. Simply add -1 to the set number.

Exceptions are hard-anodized items like centres or connection elements in steel. These components retain their original colour unless specifically required and requested.

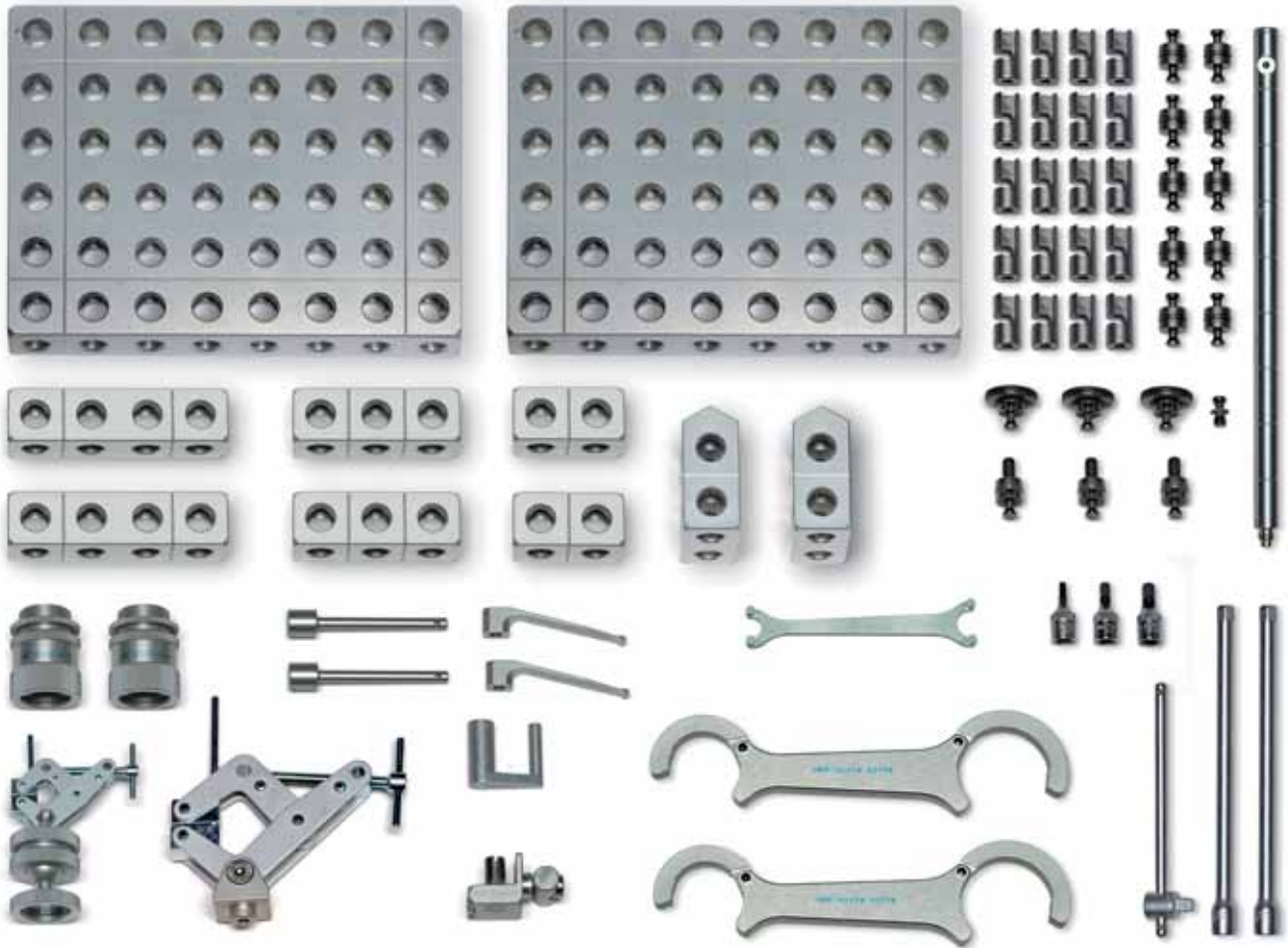

#90274 Basic Set 1

Alufix 25 (67-pcs), 4,5 kg

Nr.	Qty.	Name
21352	2	Base plate 25x150x200
21373	2	Bar 25x25x50
21374	2	Bar 25x25x75
21375	2	Bar 25x25x100
22256	2	Delta block 120° Form 3
82673	1	Quick connector set (36 pcs)
21500	1	Bolt, shortened for thread
81493	1	Tools (10 pcs)

Nr.	Qty.	Name
82139	2	Screw-jack h38-50
80925	1	Screw clamp with ball joint
80924	1	Screw clamp with joint
22258	2	Hold down spring
22260	2	Hold down stud
80743	1	Winder
22275	1	Deflector



ALUFIX CLASSIC elements can be anodized in different colours. The colour natural is standard, black (-1) is available as an alternative. Other colours on request.

#90275 Basic Set 2

Alufix 25 (103-pcs), 5,9kg

Nr.	Qty.	Name
21352	2	Base plate 25x150x200
21373	2	Bar 25x25x50
21374	2	Bar 25x25x75
21375	2	Bar 25x25x100
21376	2	Bar 25x25x125
22256	2	Delta block 120° Form 3
82673	1	Quick connector set (36 pcs)
21500	1	Bolt, shortened for thread
81493	1	Tools (10 pcs)
82139	4	Screw-jack h38-50
23239	4	Bolt disk with stud
80924	1	Screw clamp with joint
21644	2	Center
21646	2	Center
80584	3	Center with ball
80733	1	V piece 120° with ball joint
80725	1	V piece 90° with ball joint
80925	1	Screw clamp with ball joint
81791	1	Vise Set 50mm (10 pcs)
22258	5	Hold down spring
22260	2	Hold down stud
22263	3	Hold down stud
22268	3	Traverse holder with heel
80743	1	Winder
22275	1	Deflector



Handle set up using standard Alufix Classic elements, anodized black

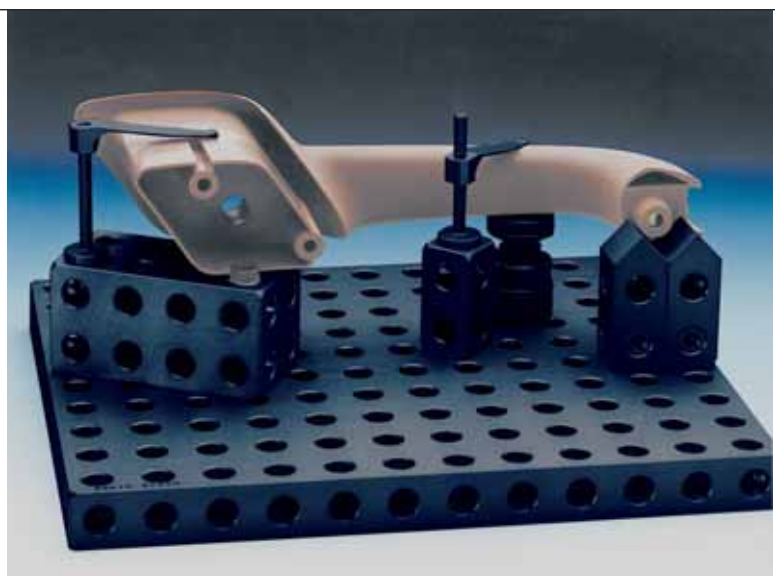

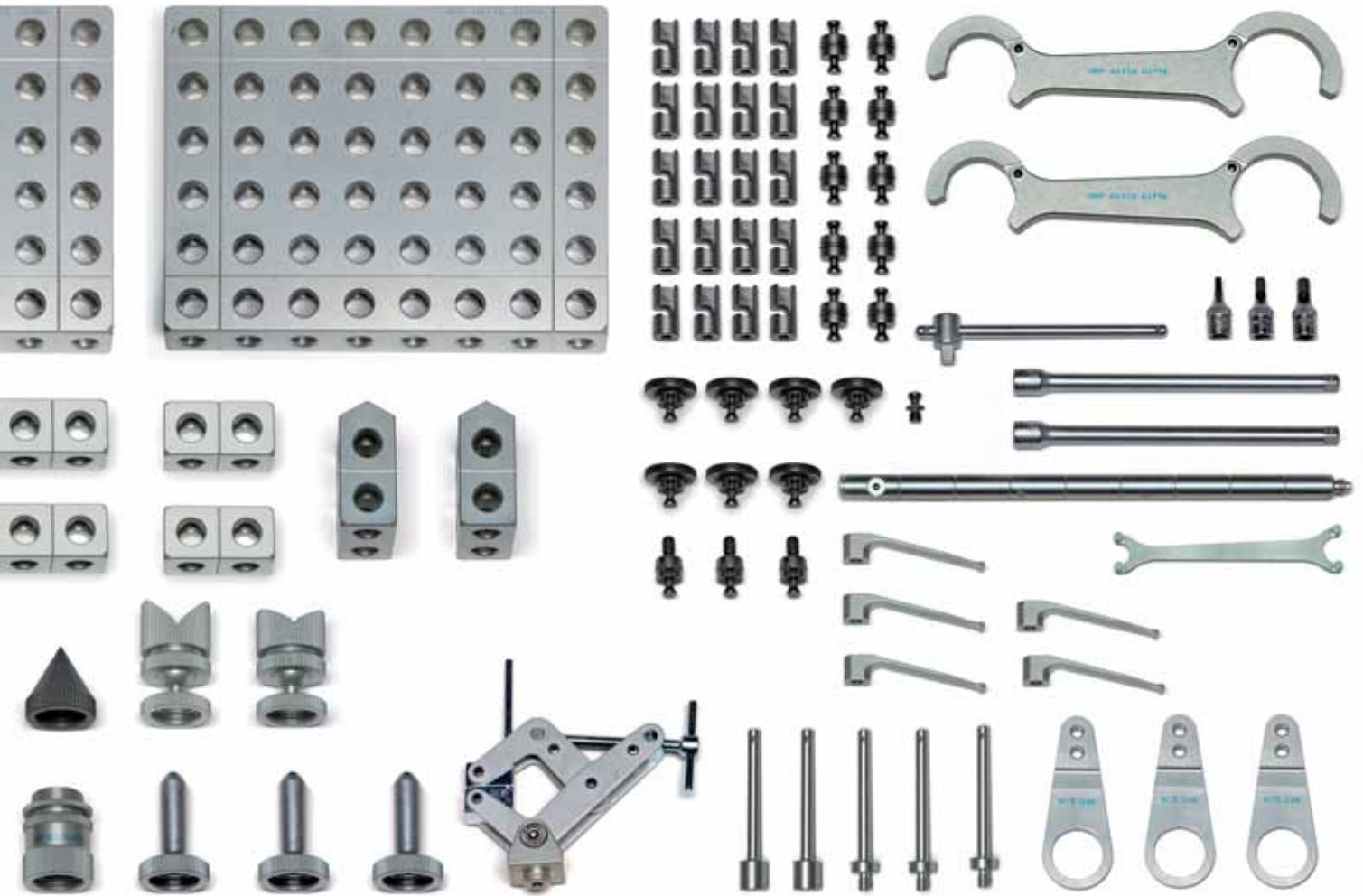

Workpiece set up on screw-jacks and secured with hold down springs





ALUFIX CLASSIC elements can be anodized in different colours. The colour natural is standard, black (-1) is available as an alternative. Other colours on request.

#90276 Basic Set 3

Alufix 25 (105-pcs), 12,6 kg

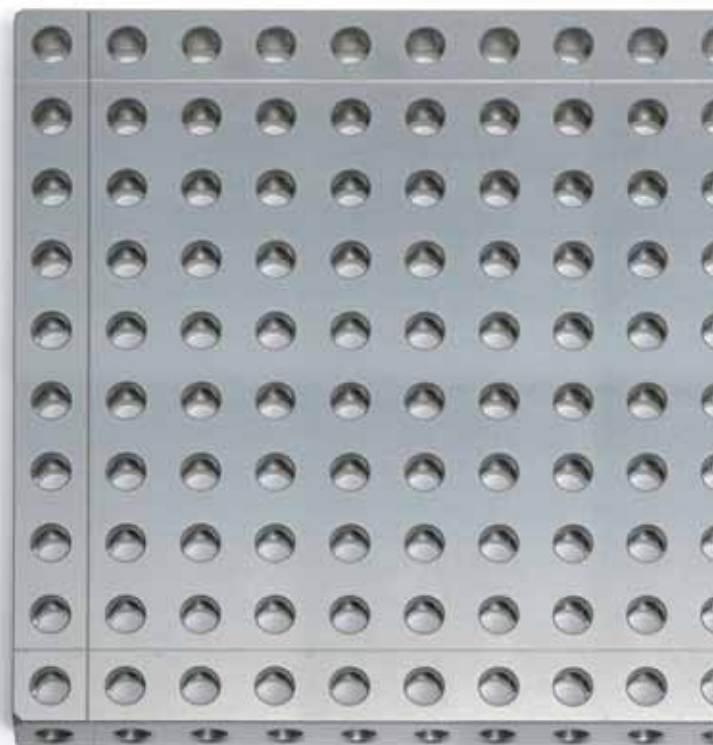
Nr.	Qty.	Name
21360	1	Base plate 25x250x300
22885	2	Base plate 25x50x250
21352	2	Base plate 25x150x200
21373	2	Bar 25x25x50
21374	2	Bar 25x25x75
21375	2	Bar 25x25x100
21376	2	Bar 25x25x125
22256	2	Delta block 120° Form 3
82673	1	Quick connector set (36 pcs)
21500	1	Bolt, shortened for thread
81493	1	Tools (10 pcs)
82139	4	Screw-jack h38-50
23239	1	Bolt disk
80925	2	Screw clamp with ball joint
21644	2	Center, short
21646	2	Center, long
80733	1	V piece 120° with ball joint
80725	1	V piece 90° with ball joint
81791	1	Vise Set 50mm (10 pcs)
22258	5	Hold down spring
22260	2	Hold down stud
22263	3	Hold down stud
22268	3	Traverse holder with heel
80743	1	Winder
22275	1	Deflector
80924	1	Screw clamp with joint
80584	3	Center with Ball D6/M24
12584	1	Storage case



 Aluminium case #12584, without inlays, version may be different to case shown, included in supply free of charge

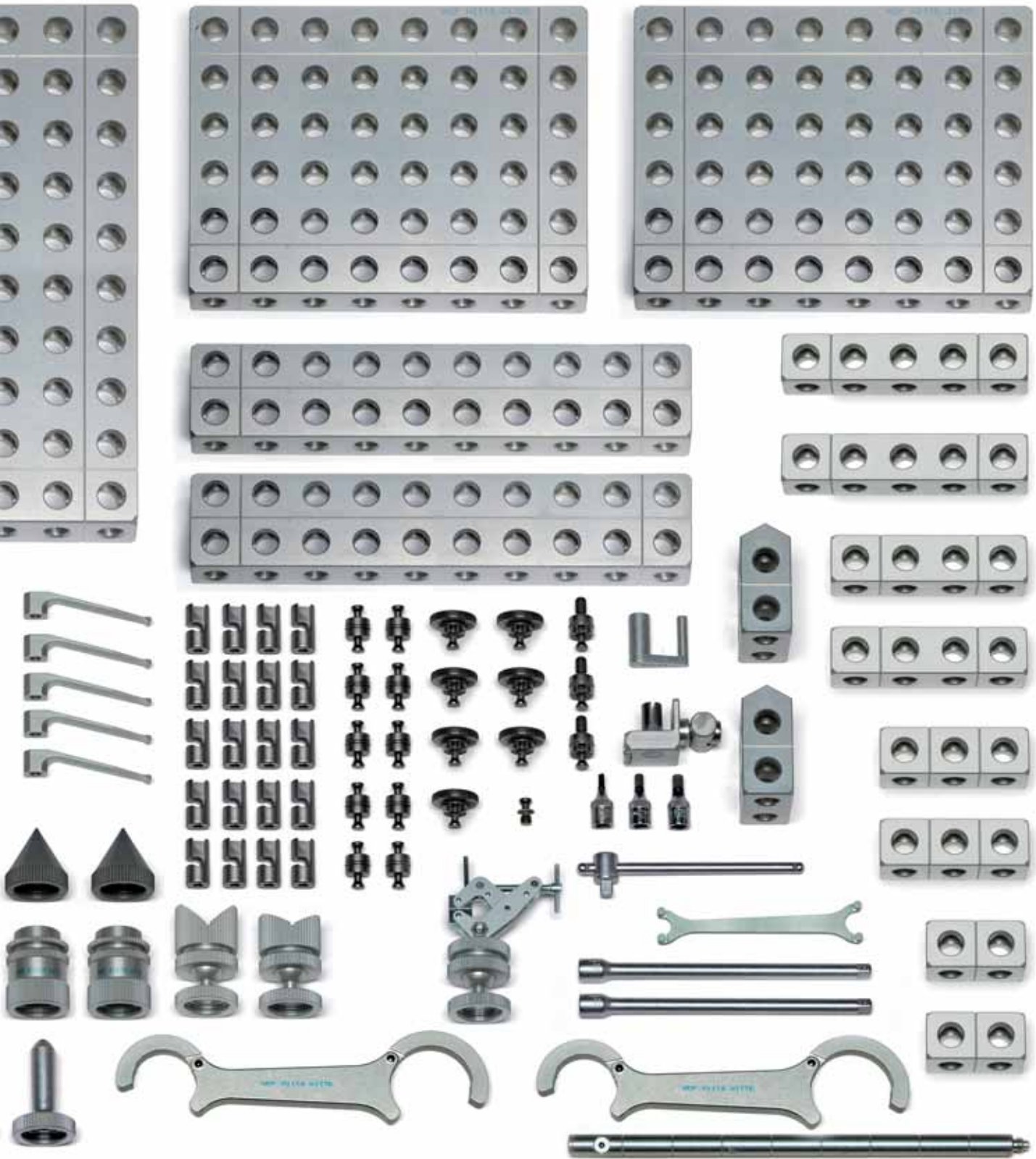



ALUFIX CLASSIC elements can be anodized in different colours. The colour natural is standard, black (-1) is available as an alternative. Other colours on request.

#90277 Basic Set 4

Alufix 25 (228-pcs), 15,5kg

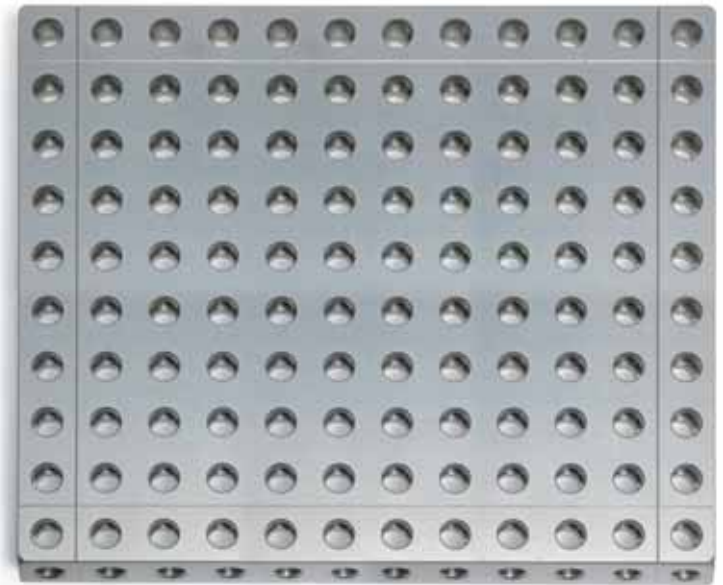
Nr.	Qty.	Name
21360	1	Base plate 25x250x300
21352	2	Base plate 25x150x200
22885	2	Base plate 25x50x250
21376	2	Bar 25x25x125
21375	2	Bar 25x25x100
21374	2	Bar 25x25x75
21373	2	Bar 25x25x50
23233	2	Bar 1D
21987	2	V block 120°
22256	2	Delta block 120° Form 3
82673	2	Quick connector set (36-pcs)
21500	1	Bolt, shortened for thread
25654	3	Bolt f. grid plate + keyless chuck
23228	2	Twin bolt for bar 1D/2D
23241	2	Bolt disk
80531	3	Crosspiece nut
81493	1	Tools (10-pcs)
82139	4	Screw-jack h38-50
23239	1	Bolt disk
21644	2	Center, short
21646	2	Center, long
80584	3	Center with ball
80941	2	Magnetic holder with ball joint
80733	1	V piece 120° with ball joint
80725	1	V piece 90° with ball joint
81111	2	C clamp adjustable
80925	1	Screw clamp with ball joint
81791	1	Vise Set 50mm (10-pcs)
82080	1	3 jaw keyless chuck compl. ø80
22258	5	Hold down spring
22260	2	Hold down stud
22263	3	Hold down stud
22268	3	Traverse holder with heel
80743	1	Winder
22275	1	Deflector
80924	1	Screw clamp with joint
81020	1	Clamp Set 9 M6S (69-pcs)
12584	1	Storage case



 Aluminium case #12584, without inlays, version may be different to case shown, included in supply free of charge

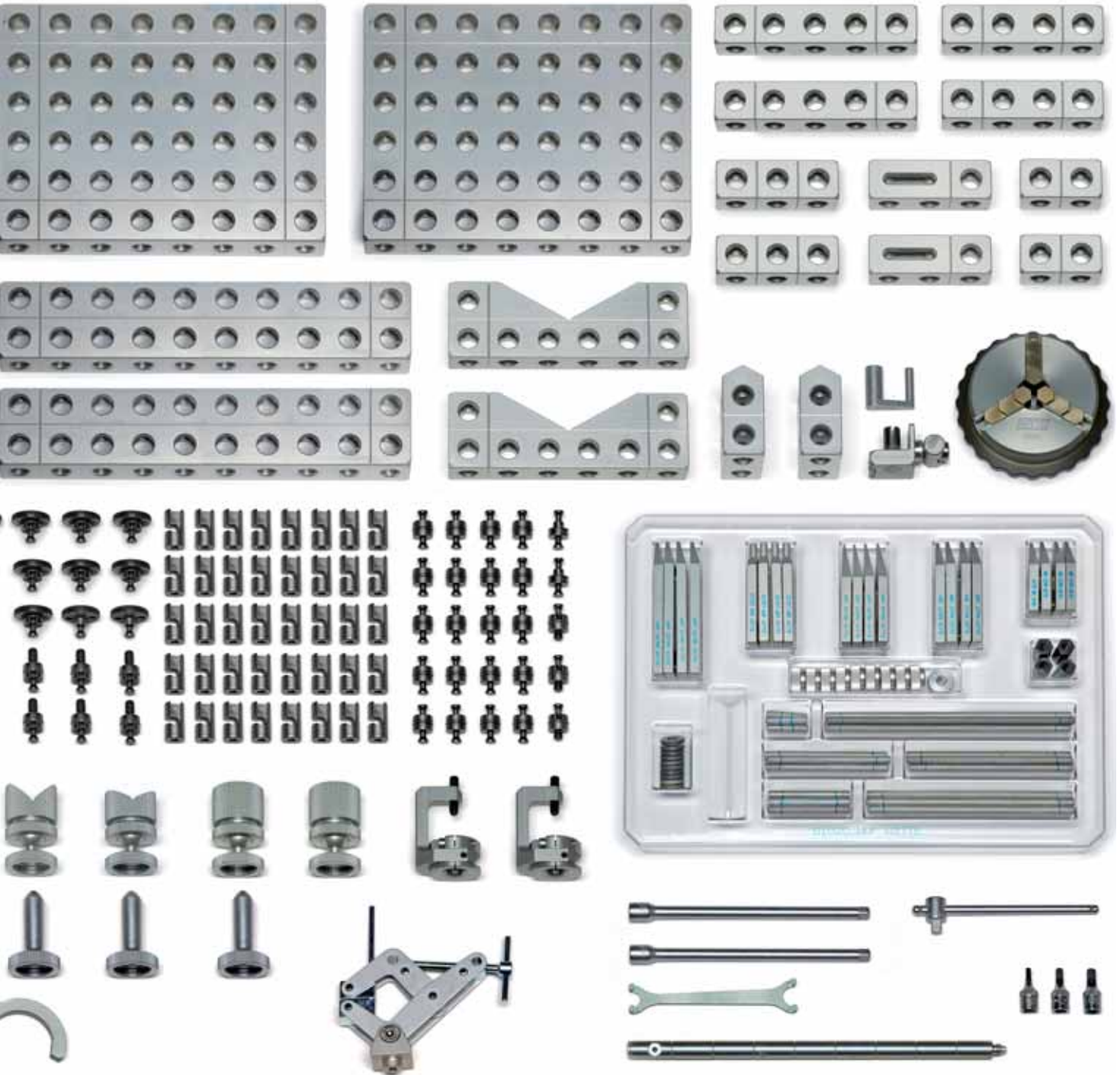

ALUFIX CLASSIC elements can be anodized in different colours. The colour natural is standard, black (-1) is available as an alternative. Other colours on request.

#90278 Basic Set 5

Alufix 25 (344-pcs), 49,8 kg

Nr.	Qty.	Name
21361	2	Base plate 25x300x400
21360	1	Base plate 25x250x300
21352	2	Base plate 25x150x200
22885	2	Base plate 25x50x250
21376	2	Bar 25x25x125
21375	2	Bar 25x25x100
21374	2	Bar 25x25x75
21373	2	Bar 25x25x50
81443	2	Strut 25x25x125
81444	2	Strut 25x25x250
23233	2	Bar 1D
81028	2	Double knuckle
21987	2	V block 120°
22256	2	Delta block 120° Form 3
22253	2	Delta block 120° Form 2
81285	1	Quick connector set (70-pcs)
82673	2	Quick connector set (36-pcs)
80531	3	Crosspiece nut
23228	2	Bolt for bar 1D/2D
25654	3	Bolt f. grid plate + keyless chuck
21500	1	Bolt, shortened for thread
81493	2	Tools (10-pcs)
82139	4	Screw-jack h38-50
23239	1	Bolt disk
23241	2	Bolt disk
21644	4	Center, short
21646	4	Center, long
80584	5	Center with ball
80733	1	V piece 120° with ball joint
80725	1	V piece 90° with ball joint
80661	2	True line stud
80941	2	Magnetic holder with ball joint
81212	2	Autocenter
81111	4	C clamp adjustable
80925	4	Screw clamp with ball joint
22005	2	Moulding cap
81791	1	Vise Set 50mm (10 pcs)
80685	1	Compound resin 400g
81832	2	Forming jaw with bushes (3 pcs)
82080	1	3 jaw keyless chuck compl. ø80
22258	5	Hold down spring
22260	2	Hold down stud

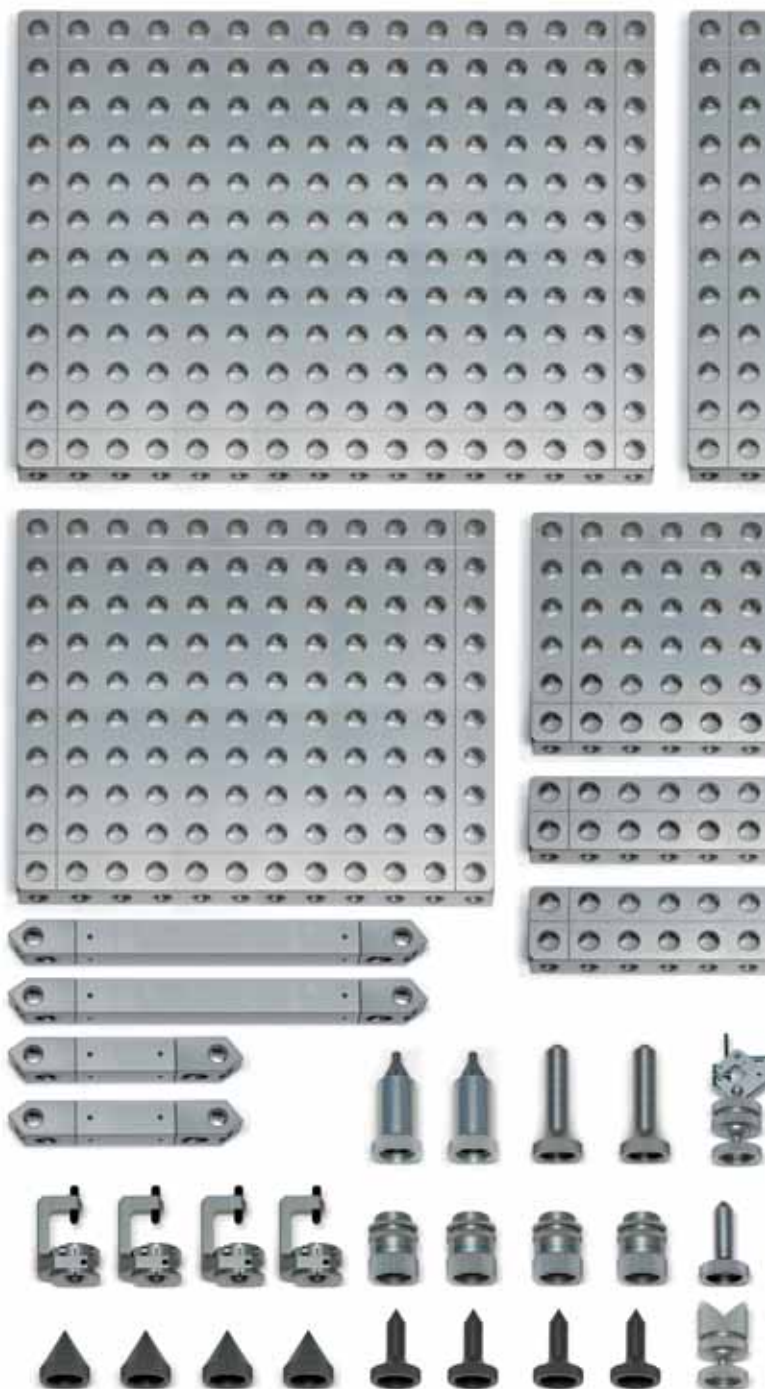

Nr.	Qty.	Name
22263	3	Hold down stud
22268	3	Traverse holder for stud
80743	1	Winder
22275	1	Deflector

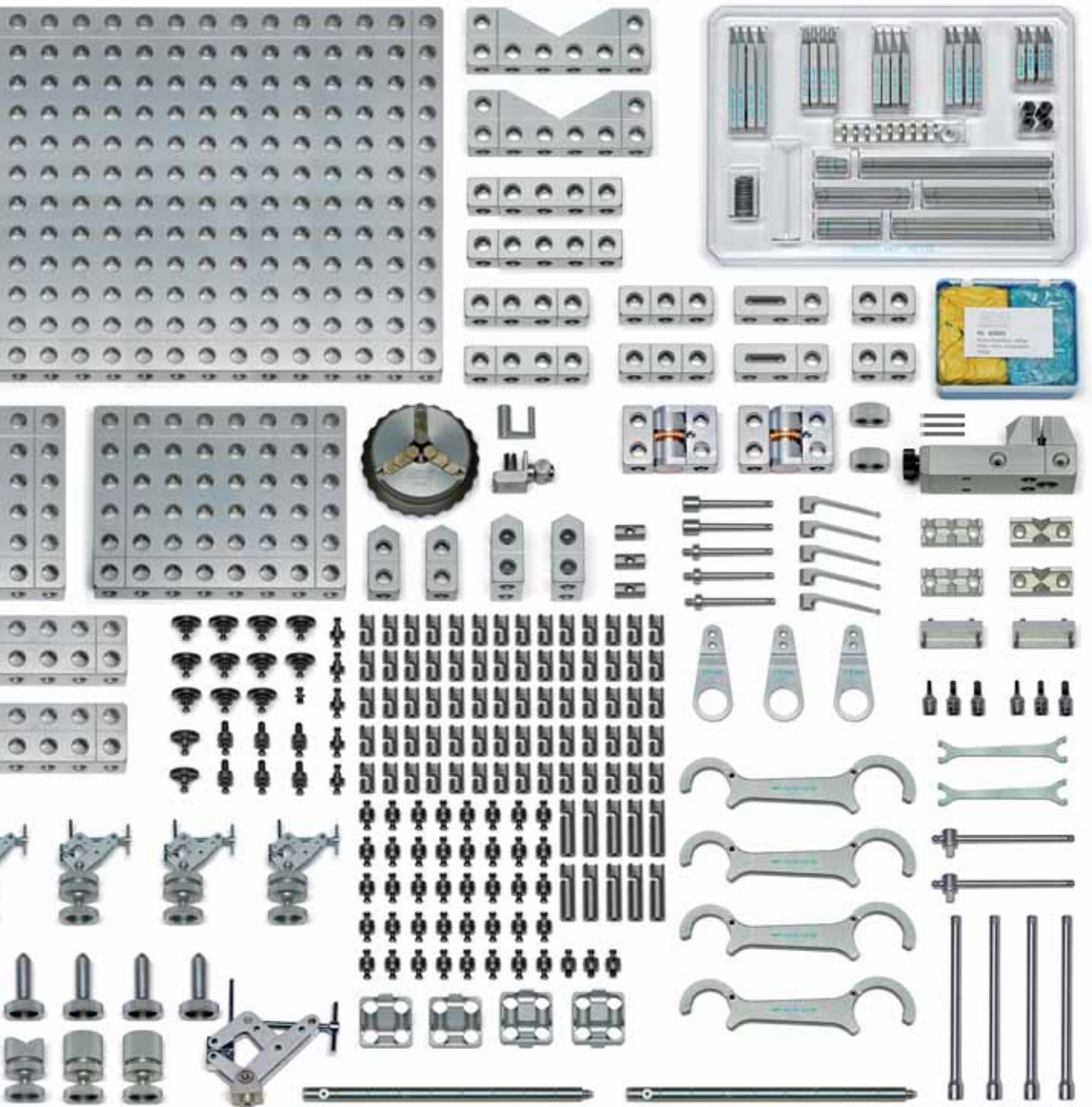

Nr.	Qty.	Name
80924	1	Screw clamp with joint
80604	2	Base for screw clamp
81020	1	Clamp Set 9 M6S (69 pcs)
12584	1	Storage case



ALUFIX CLASSIC elements can be anodized in different colours. The colour natural is standard, black (-1) is available as an alternative. Other colours on request.

Aluminium case #12584, without inlays, version may be different to case shown, included in supply free of charge

#98156 Basic Set 6

Alufix 25 (332-pcs), 49,8 kg

Nr.	Qty.	Name
33502	1	Base plate 25x300x500 AF25
56492	2	Base plate 25x300x300 AF25
21373	4	Bar 25x25x50 AF25
21374	4	Bar 25x25x75 AF25
21375	4	Bar 25x25x100 AF25
21376	4	Bar 25x25x125 AF25
21824	4	Bar 50x50x750 Light AF25
24246	4	Bar 50x50x350 Light AF25
23325	8	Coupling 50x50 single AF25
23330	4	Coupling 50x50 double AF25
23233	2	Bar 25x25x75 1D AF25
23232	3	Base plate 2D 25x50x75 AF25
81028	2	Double knuckle AF25
82437	3	Cross guiding slide, AF25 with stop
81444	2	Strut 250 AF25
81327	2	Strut 500 AF25
21987	2	V-Block 120° 25x50x150 AF25
22253	4	Deltablock 120° Form2 AF25
23240	60	Lock SW5 AF25
23223	30	Twin bolt AF25
25743	30	Combi bolt shortened AF25
21500	10	Bolt shortened AF25
23228	8	Twin bolt AF25 for Bar 1D/2D
21386	10	Positioning sleeve ϕ 12,5
81493	2	Tool AF25 (10pcs)
21385	10	Positioning sleeve ϕ 12,5 AF25
23241	5	Bolt disk ϕ 6,7/M24 AF25
80701	10	Connector Set M6/25 AF25
82139	2	Screw-jack h=38/50 M24x1
82033	4	Screw-jack h=70/105 M24x1
20628	6	Screw-jack extension 6/M24x1
23286	6	Screw-jack extension 12/M24x1
23239	5	Bolt Disk with stud ϕ 12,5/M24
21644	2	Center ϕ 32/M24
21646	2	Center, ϕ 12,5/M24 50 long
94543	2	Autocenter, star shaped, M24x1
95532	2	Autocenter, star shaped, M24x1
81112	3	Stop and support 180° AF25
81113	2	Stop and support 90° AF25
80531	10	Nut M6/25 AF25
80585	3	Center w. ball ϕ 8/M24

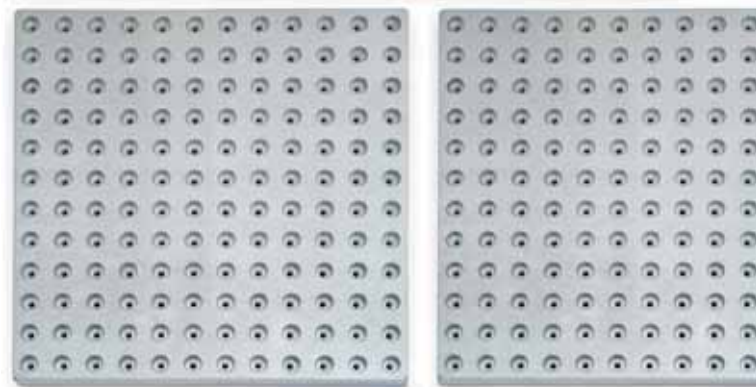
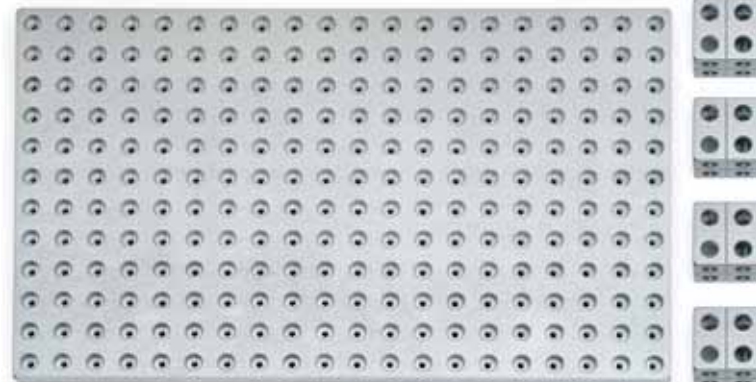

Nr.	Qty.	Name
80733	2	V Block 120° with ball joint
80590	2	True line stud ϕ 15/M24/32,6
22647	2	Crossover male/male M24x1
93443	8	Hold down spring f.sens. surfaces
22263	6	Hold down stud M6 AF25



ALUFIX CLASSIC elements can be anodized in different colours. The colour natural is standard, black (-1) is available as an alternative. Other colours on request.

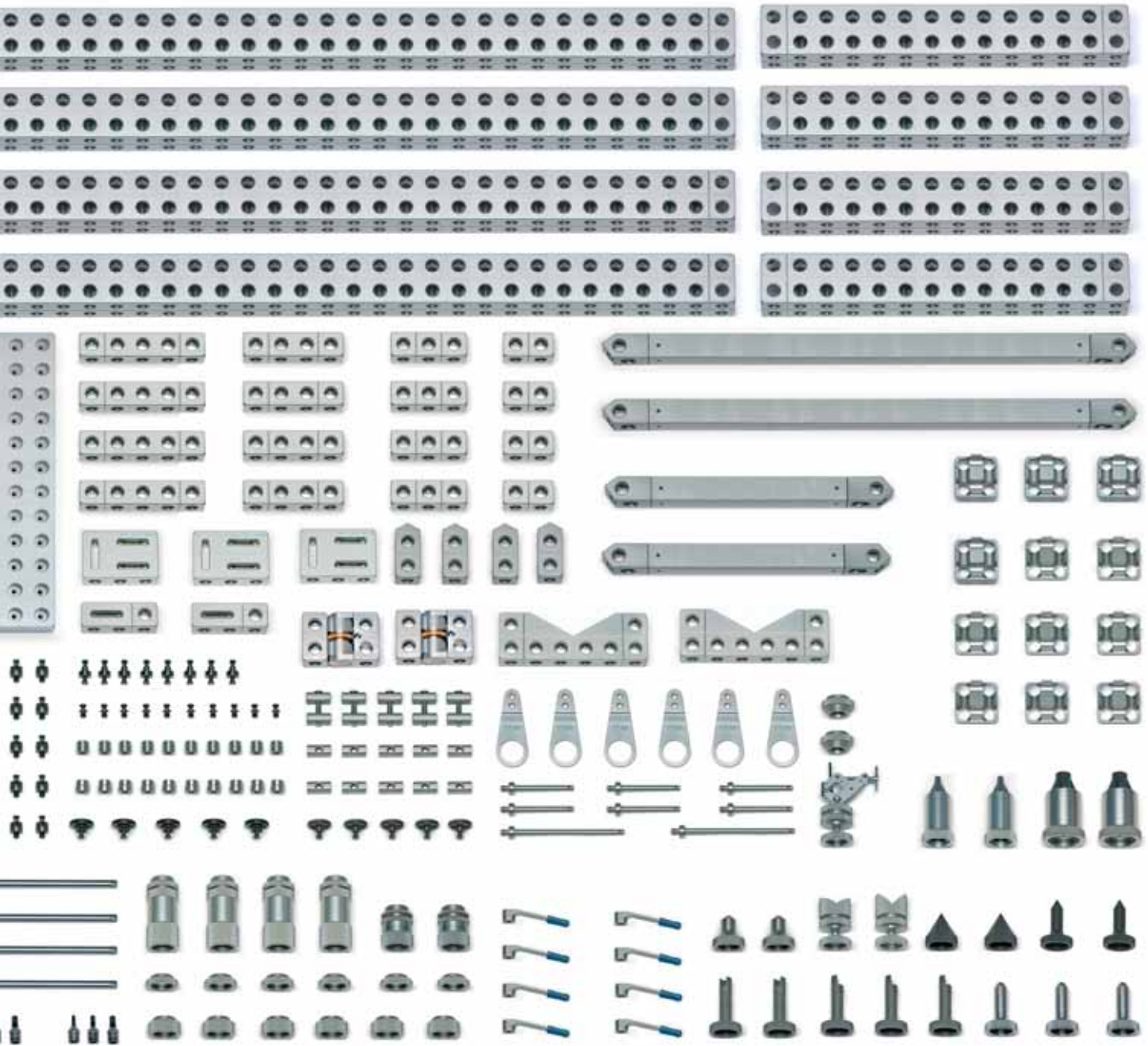

Nr.	Qty.	Name
24885	2	Hold down stud M6 AF25 I125
22268	6	Traverse holder with heel 6/60
80743	1	Winder AF25
22275	1	Deflector AF25
80924	1	Screw clamp with ball joint

i **Supply includes**
3 cross guiding slides with slide stop #82437 (not shown)



i **Recommendation:**
For storage of elements workstation #282562 is available, page 27



#82689 Basic Set 7

Alufix 25 (418-pcs), 54 kg

Nr.	Qty.	Name
22885	2	Base plate 25x50x250
21707	1	Base plate 25x50x500
21360	2	Base plate 25x250x300
21352	4	Base plate 25x150x200
21362	1	Base plate 25x300x500
21372	2	Bar 25x25x25
21373	2	Bar 25x25x50
21374	2	Bar 25x25x75
21375	3	Bar 25x25x100
21376	3	Bar 25x25x125
22963	2	Bar 25x25x200
22882	2	Bar 25x25x250
23233	2	Bar 1D
23232	2	Base plate 2D
81028	2	Double knuckle
82172	2	Roller slide
82462	2	Cross roller slide
81444	2	Strut 25x25x250
21992	2	V block 90°
21987	2	V block 120°
22235	2	Delta block 90° Form 1
22177	2	Delta block 90° Form 2
22174	2	Delta block 90° Form 3
22241	2	Delta block 120° Form 1
22253	2	Delta block 120° Form 2
22256	2	Delta block 120° Form 3
23240	60	Lock
23223	30	Twin bolt
21500	31	Bolt, shortened for thread
25654	2	Twin bolt for grid base plate
23225	6	Combi bolt
23228	5	Twin bolt for bar 1D
25743	8	Combi bolt shortened
81493	2	Tools (10 pcs)
21385	10	Positioning sleeves
21869	6	Reducer bush
21714	5	Crosspiece nut
80701	10	Connecting set
82139	6	Screw-jack h38-50
20628	6	Screw-jack extension 6mm
23286	6	Screw-jack extension 12mm
23239	8	Bolt disk

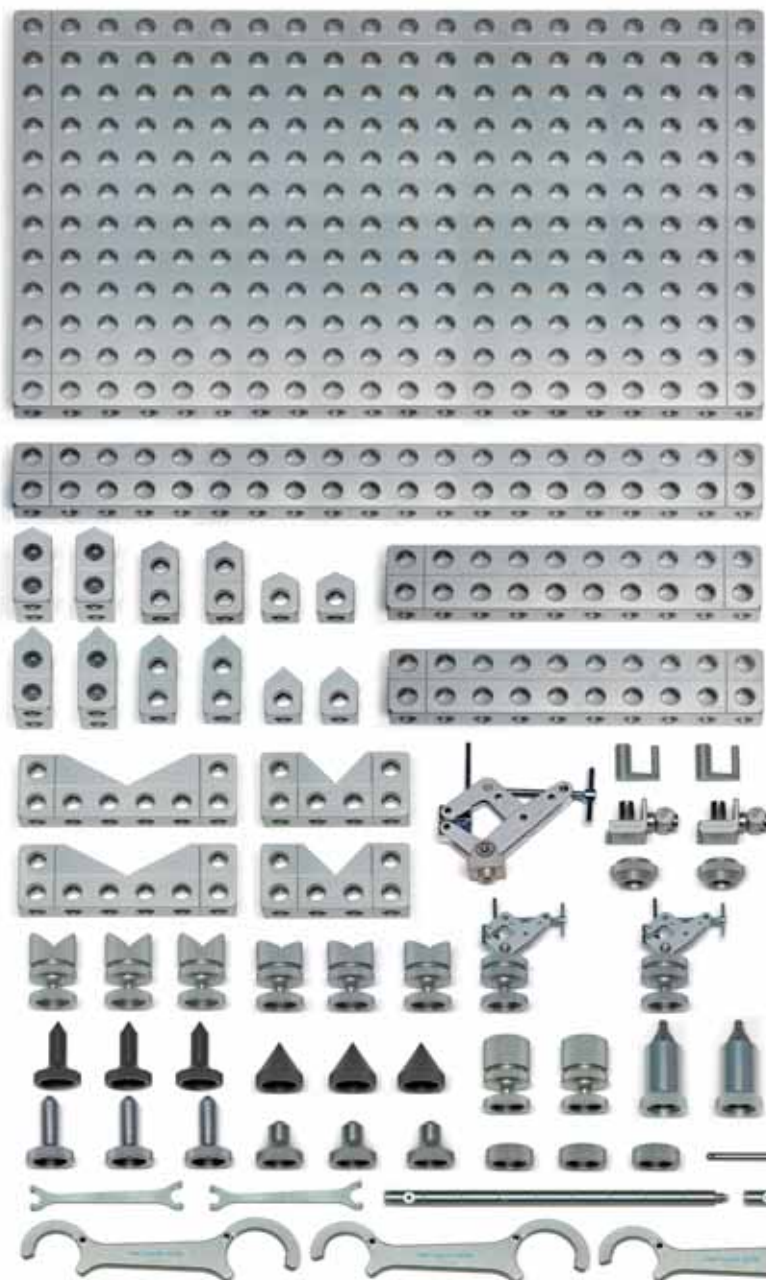

Nr.	Qty.	Name
23241	3	Bolt disk
21644	3	Center, short
21646	3	Center, long
80584	3	Center with ball
80733	3	V piece 120° with ball joint
80725	3	V block 90° with ball joint
80590	3	True line stud
80941	2	Magnetic holder with ball joint
81212	2	Autocenter
81112	2	Stop and support 180°



ALUFIX CLASSIC elements can be anodized in different colours. The colour natural is standard, black (-1) is available as an alternative. Other colours on request.

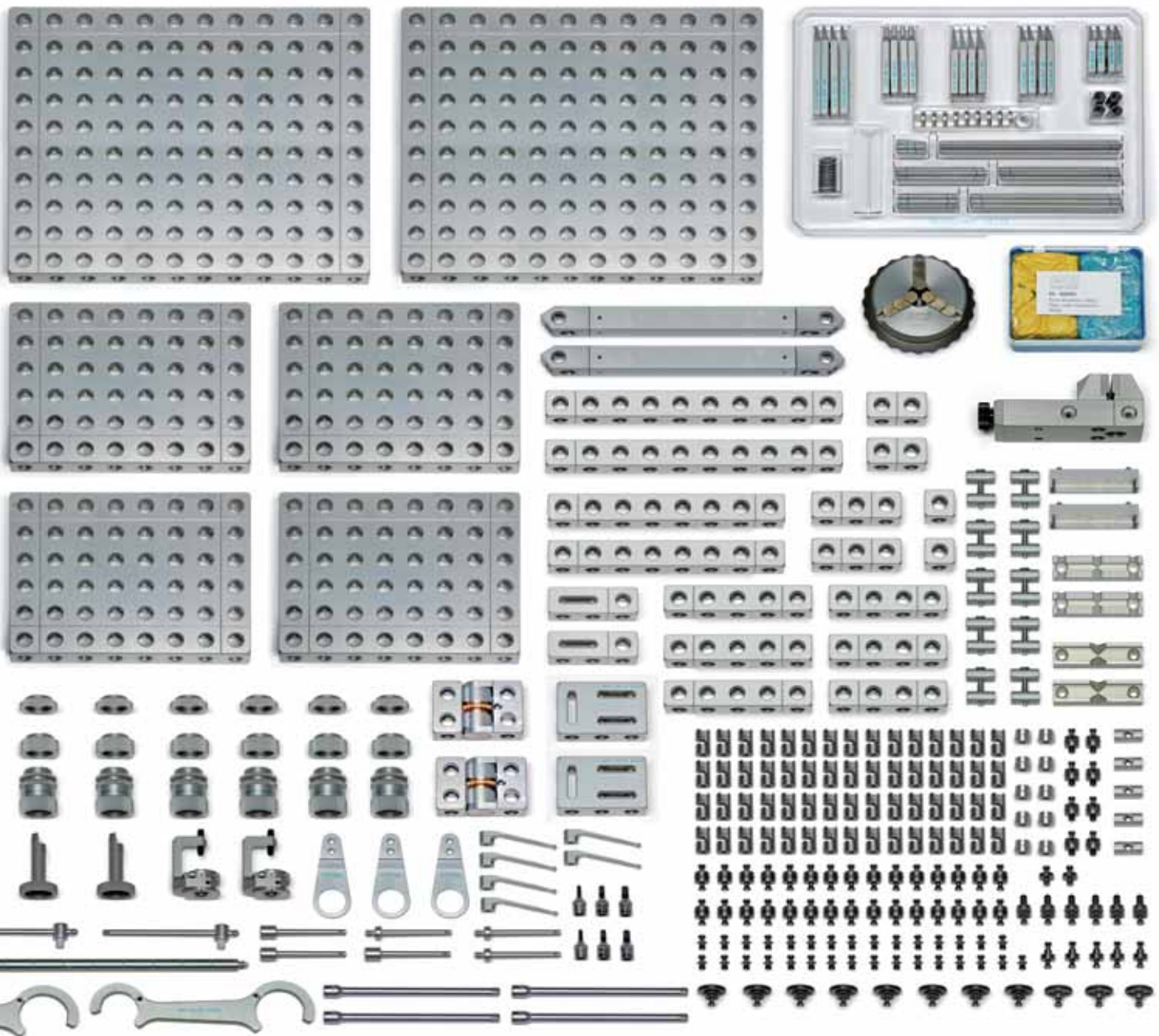

Nr.	Qty.	Name
81111	2	C clamp adjustable
22644	3	Spacer
80925	2	Screw clamp with ball joint
22647	2	Cross over male/male
81792	1	Vise Set 75mm (10 pcs)
81833	2	Forming jaw with bushes (3 pcs)
80685	1	Compound resin 400g
82080	1	3 jaw keyless chuck compl. ø80
22258	6	Hold down spring
22260	3	Hold down stud

Nr.	Qty.	Name
22263	3	Hold down stud
81020	1	Clamp set 9 M6S (69 Pcs.)
80924	1	Screw clamp 50 with joint
22268	3	Traverse holder with M6 heel
80743	2	Winder AF25
22275	2	Deflector AF25

Supply includes:
 2 cross roller slides #82462
 2 roller slides #82172
 (not shown)



Recommendation:
 For storage of elements workstation #282562 is available, page 27



#90281 Basic Set 9

Alufix 25 (434-pcs), 51kg

Nr.	Qty.	Name
21360	1	Base plate 25x250x300
21352	2	Base plate 25x150x200
22885	2	Base plate 25x50x250
21707	2	Base plate 25x50x500
21373	4	Bar 25x25x50
21374	4	Bar 25x25x75
21375	4	Bar 25x25x100
21376	4	Bar 25x25x125
22949	4	Bar Light 50x50x250
22950	4	Bar Light 50x50x500
22951	2	Bar Light 50x50x1000
22952	2	Bar Light 50x50x1500
23325	10	Coupling, single
23330	4	Coupling, double
23233	4	Bar 1D
81021	2	Bar with 1 offset unit
23232	3	Base plate 2D
81023	2	Base plate with 2 offset units
81028	2	Double knuckle
82172	2	Roller slide
82462	2	Cross roller slide
81444	2	Strut 25x25x250
81327	4	Strut 25x25x500
21992	2	V Block 90°
21987	2	Block 120°
22241	2	Delta block 120° Form 1
22253	2	Delta block 120° Form 2
22256	2	Delta block 120° Form 3
23240	80	Lock
23225	6	Kombi bolt M6
23228	10	Twin bolt for bar 1D
23223	40	Twin bolt
21500	10	Bolt, shortened for thread
25743	8	Combi bolt shortened
81493	2	Tools (10-pcs)
21385	40	Positioning sleeves
80701	30	Connection element M6
82139	6	Screw-jack h38-50
20628	6	Screw-jack extension 6mm
23286	6	Screw-jack extension 12mm
23239	10	Bolt disk
23241	5	Bolt disk

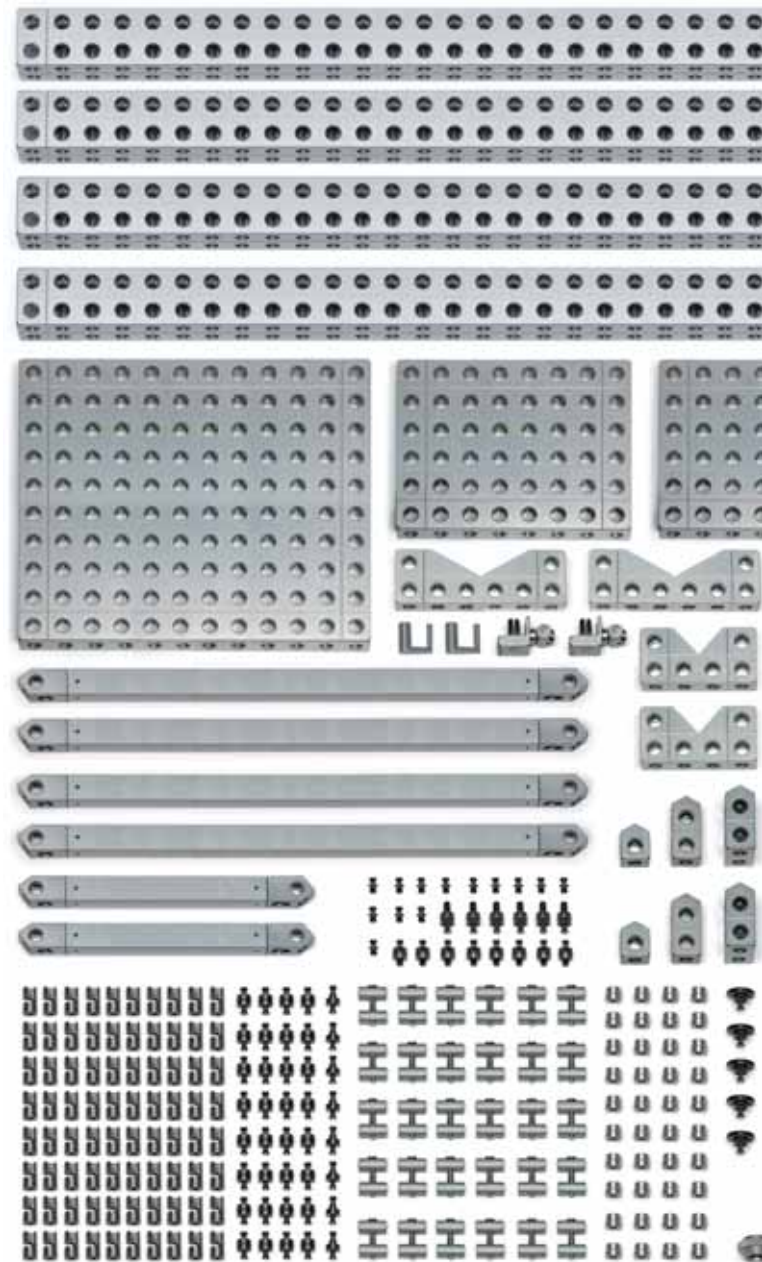

Nr.	Qty.	Name
21644	3	Center, short
21646	3	Center, long 50
21648	2	Center, long 70
80584	4	Center with ball
80733	3	V Block 120° with ball joint
80927	3	Knife V 120° with ball joint
80941	4	Magnetic holder with ball joint
81212	3	Autocenter
82252	3	Autocenter
81112	2	Stop and support 180°



ALUFIX CLASSIC elements can be anodized in different colours. The colour natural is standard, black (-1) is available as an alternative. Other colours on request.

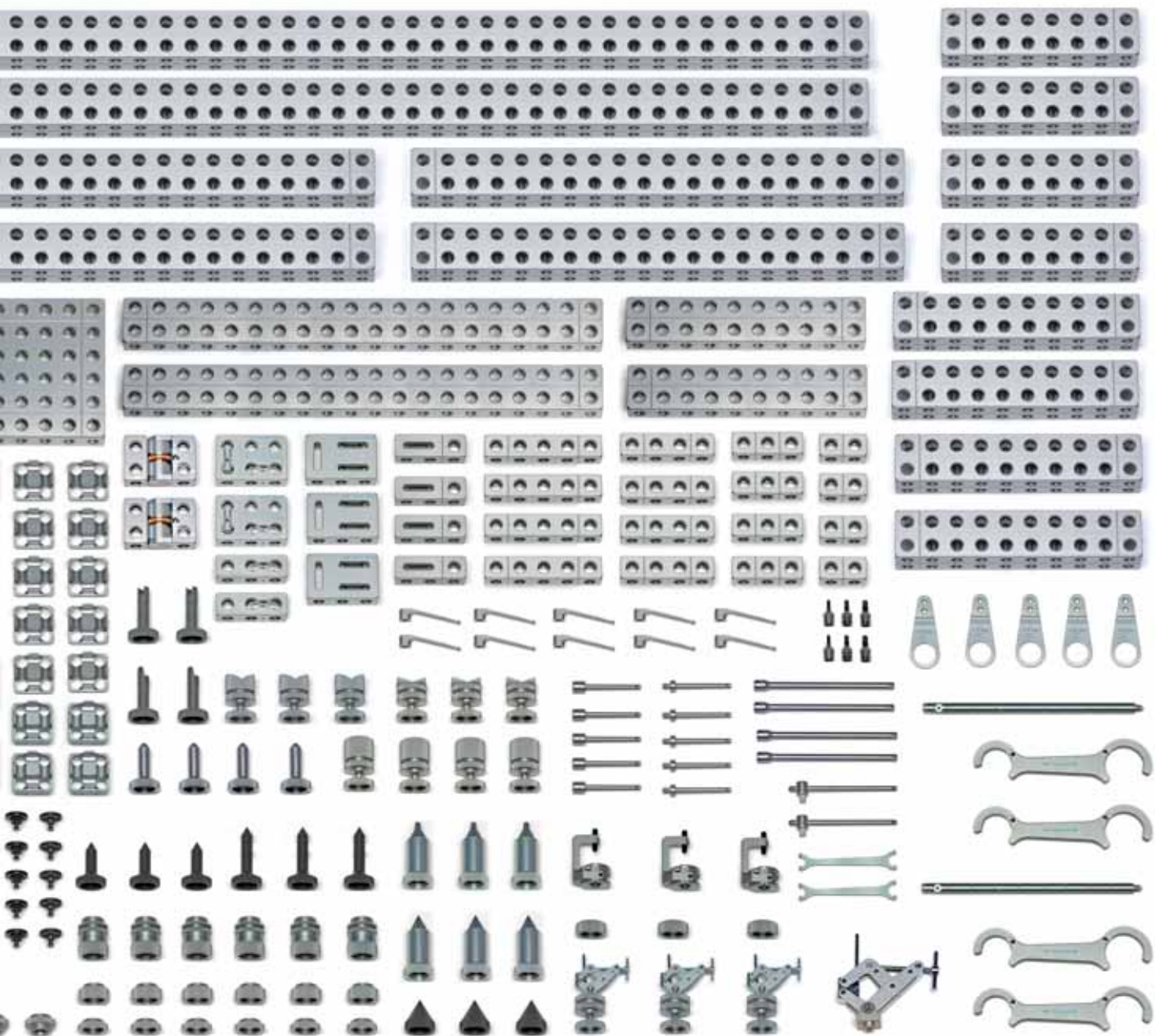

Nr.	Qty.	Name
81113	2	Stop and support 90°
81111	3	C clamp adjustable
80925	3	Screw clamp with ball joint
22644	3	Spacer
22647	2	Cross over male/male
22258	10	Hold down spring
22260	5	Hold down stud
22263	5	Hold down stud
22268	5	Traverse holder for stud
80743	2	Winder

Nr.	Qty.	Name
22275	2	Deflector
80924	1	Screw clamp with joint
80604	2	Base for toggle clamp

Supply includes:
 2 cross roller slides #82462
 2 roller slides #82172
 (not shown)



Recommendation:
 For storage of elements
 workstation #282727 is
 available, page 27





#90283 Extension Set 1

Alufix 25 Light (97-pcs), 17 kg

Nr.	Qty.	Name
20426	2	Bar Light 50x50x150
22949	2	Bar Light 50x50x250
22950	2	Bar Light 50x50x500
22951	2	Bar Light 50x50x1000
22952	2	Bar Light 50x50x1500
23330	4	Coupling, double
23325	8	Coupling, single
23240	50	Lock
23223	25	Twin bolt

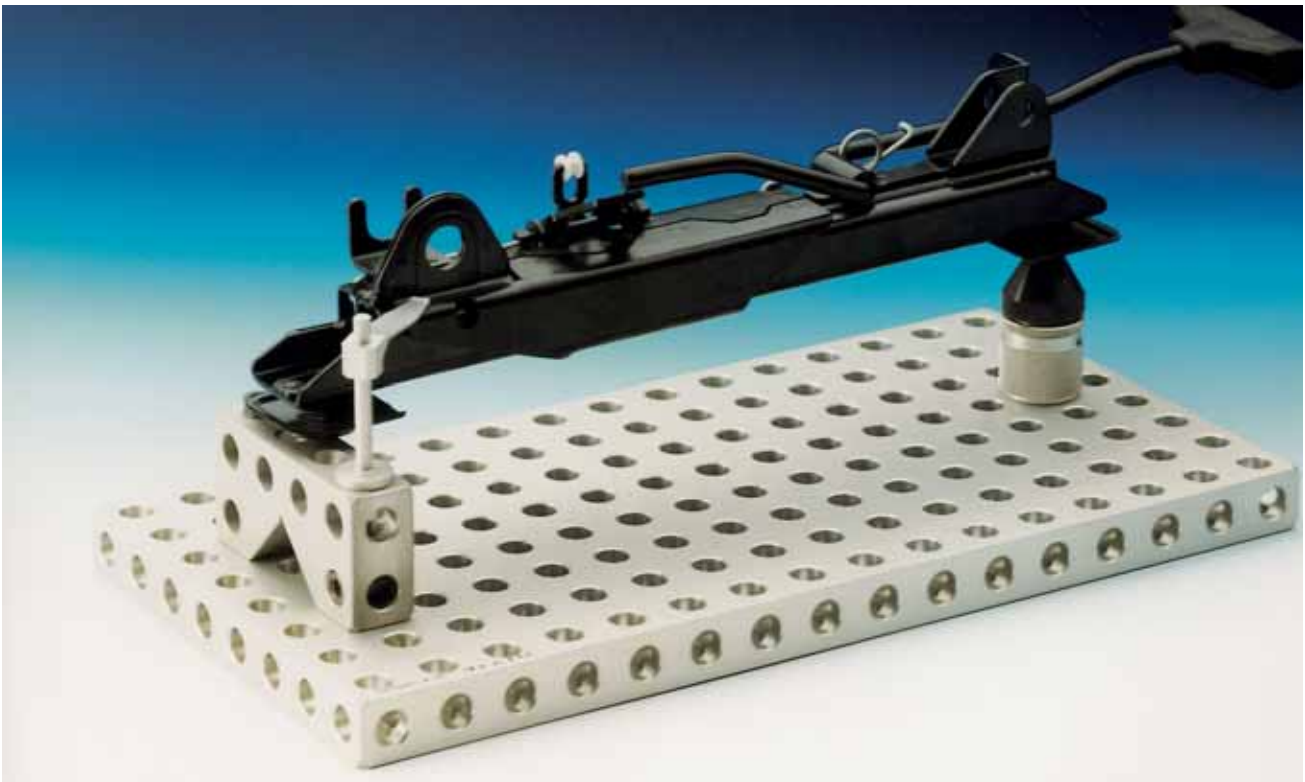

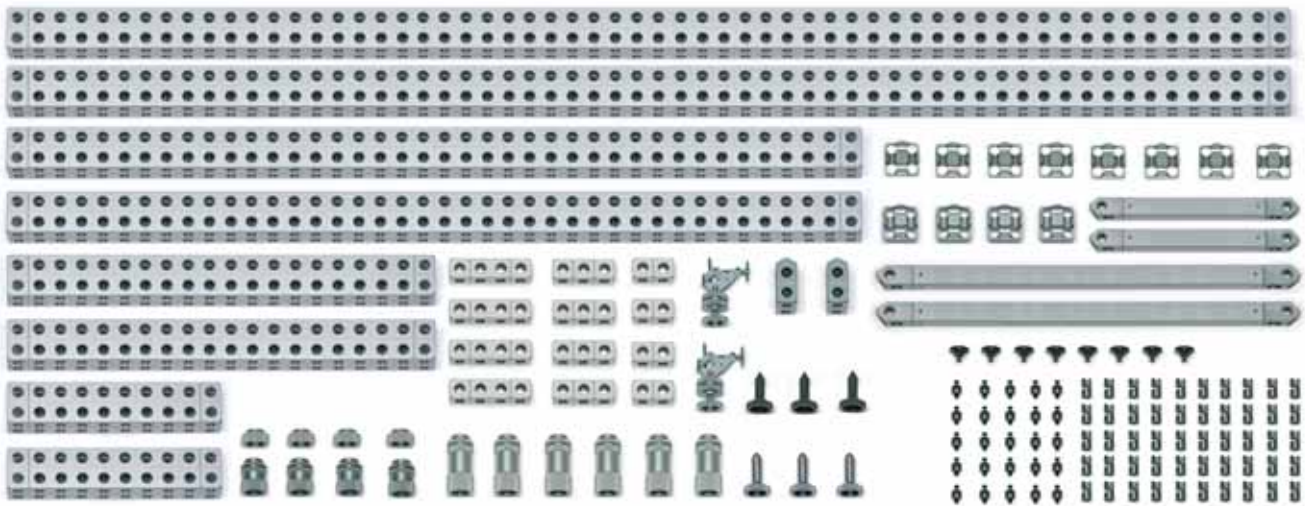

#90284 Extension Set 2

Alufix 25 Light (143-pcs), 21 kg

Nr.	Qty.	Name
21373	4	Bar 25x25x50
21374	4	Bar 25x25x75
21375	4	Bar 25x25x100
22949	2	Bar Light 50x50x250
22950	2	Bar Light 50x50x500
22951	2	Bar Light 50x50x1000
22952	2	Bar Light 50x50x1500
23330	4	Coupling, single
23325	8	Coupling, double
81444	2	Strut 25x25x250
81327	2	Strut 25x25x500
22256	2	Delta block 120° Form 3
23240	50	Lock
23223	25	Twin bolt
82139	4	Screw-jack h38-50
82033	6	Screw-jack h70-105
23286	4	Screw-jack extension 12mm
23239	8	Bolt disk
21646	3	Center
80584	3	Center with ball
80925	2	Screw clamp with ball joint

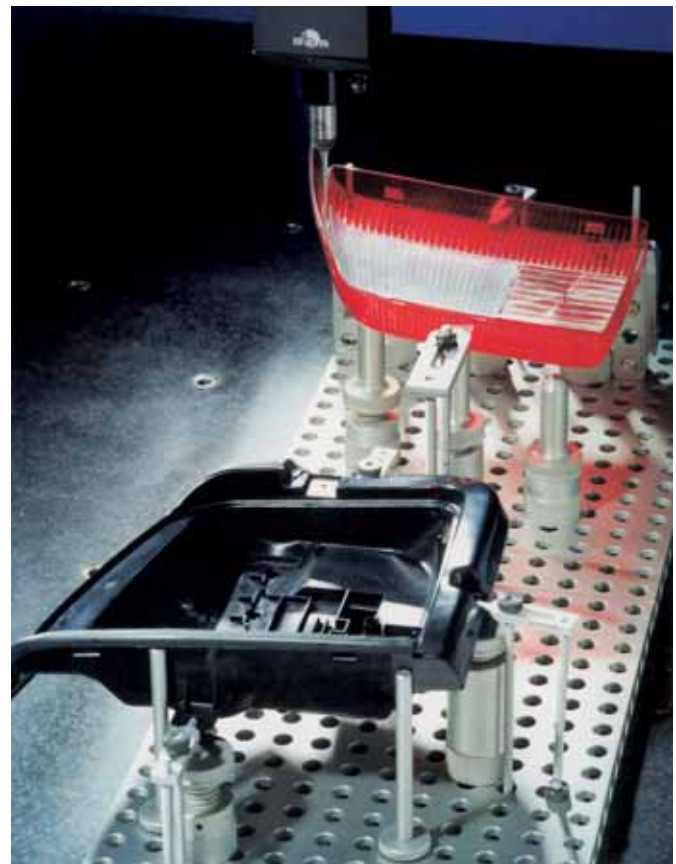

ALUFIX CLASSIC elements can be anodized in different colours. The colour natural is standard, black (-1) is available as an alternative. Other colours on request.

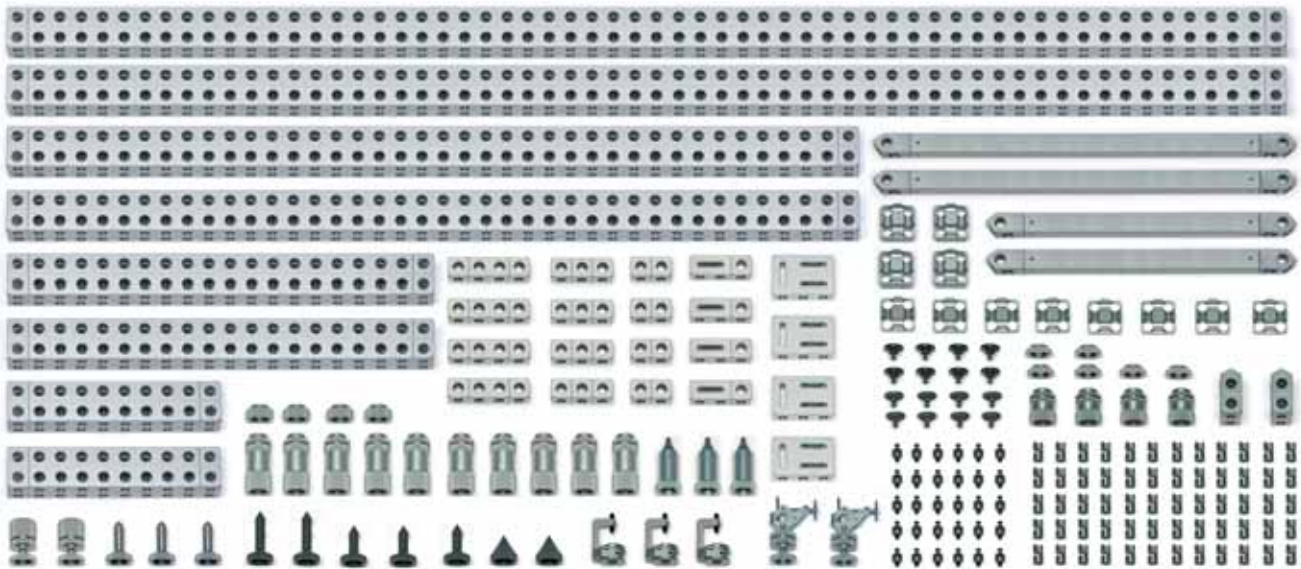

#90285 Extension Set 3

Alufix 25 Light (209-pcs), 24,5 kg

Nr.	Qty.	Name
21373	4	Bar 25x25x50
21374	4	Bar 25x25x75
21375	4	Bar 25x25x100
22949	2	Bar Light 50x50x250
22950	2	Bar Light 50x50x500
22951	2	Bar Light 50x50x1000
22952	2	Bar Light 50x50x1500
23330	4	Coupling, double
23325	8	Coupling, single
23233	4	Bar 1D
23232	4	Base plate 2D
81028	2	Double knuckle
81445	2	Strut 25x25x375
81329	2	Strut 25x25x750
22256	2	Delta block 120° Form 3
23240	60	Lock
23223	30	Twin bolt
23228	10	Twin bolt for bar 1D
82139	4	Screw-jack h38-50
82033	10	Screw-jack h70-105
20628	6	Screw-jack extension 6mm
23286	4	Screw-jack extension 12mm
23239	8	Bolt disk
23241	8	Bolt disk

Nr.	Qty.	Name
21644	2	Center, short
21646	3	Center, long 50
21648	2	Center, long 70
80584	3	Center with ball
80941	4	Magnetic holder with ball joint
82252	2	Autocenter
81111	3	C clamp adjustable
80925	2	Screw clamp with ball joint



Workstation, metal, lockable

#282562, suitable for Basic Sets 6 and 7

H x W x D: 780 x 570 x 960
Weight unloaded approx. 85kg

Storage of Alufix components in 6 clearly laid out, spacious and fully extendable drawers, also suitable for Alufix 40 Bars 80x80.

Two top drawers are equipped with inlays for small components. Lower drawers equipped with non-slip mats.

Load capacity per drawer 75 kg



Workstation, metal, lockable

#282727, suitable for Basic Sets 9 and extension sets

H x W x D: 780 x 570 x 1030
Weight unloaded approx. 88kg

Storage of Alufix components in 6 clearly laid out, spacious and fully extendable drawers, also suitable for Alufix 40 Bars 80x80.

Additional storage compartment mounted at rear for safe storage of long bars and profiles 50x50.

Two top drawers are equipped with inlays for small components. Lower drawers equipped with non-slip mats.

Load capacity per drawer 75 kg



Storage compartment

#51753 for storage of long bars 50x50

H x W x D: 660 x 480 x 68 mm

Storage of long bars in 6 pockets.

Assembly on rear of workstation with M8 screws included in supply.



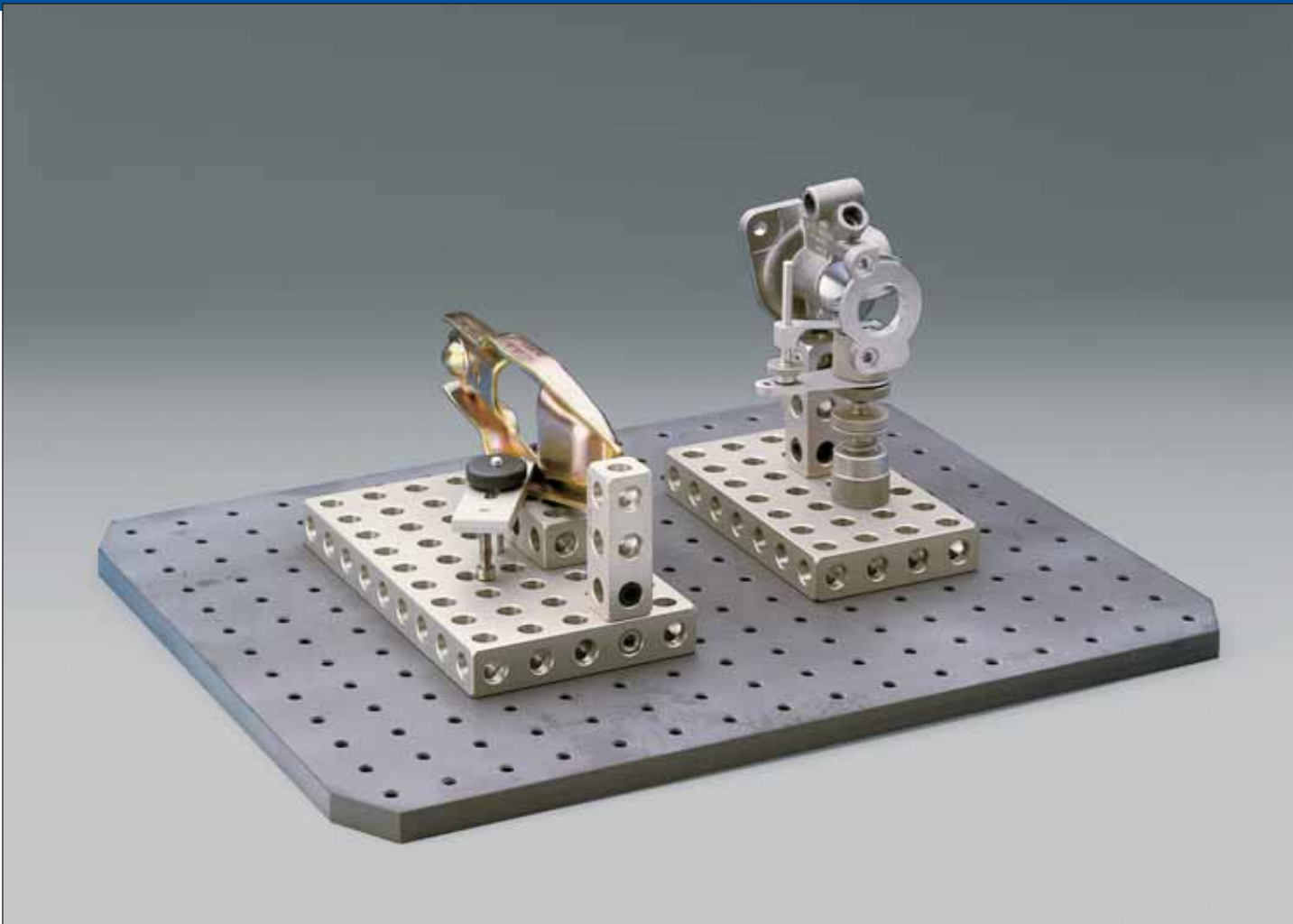

Information:

Weights mentioned in the catalogue are non-committal and approximate, and can deviate considerably i.e. through technical changes.

- We reserve the right to make technical changes.
- Where differences between photos and parts lists exist, the parts lists are decisive.
- Due to fluctuations of copper content in aluminum - alloy colour deviations may occur during anodizing.
- All Alufix components are also available anodized black e.g. for use with optical measuring systems. Exceptions are standard hard anodized items such as pins, connection elements in steel etc. These items maintain their usual characteristics but can be changed on request.

All details on our products in this catalogue, especially illustrations, drawings, dimensions and statements on performance are to be regarded as approximate average values. We reserve the right to change design, technical data, dimensions and weights.

The indicated standards, similar technical regulations as well as technical details, descriptions and illustrations are valid at time of printing. Our general trading conditions are valid. Our quotations are decisive.



Modern measuring technology at the Witte plant

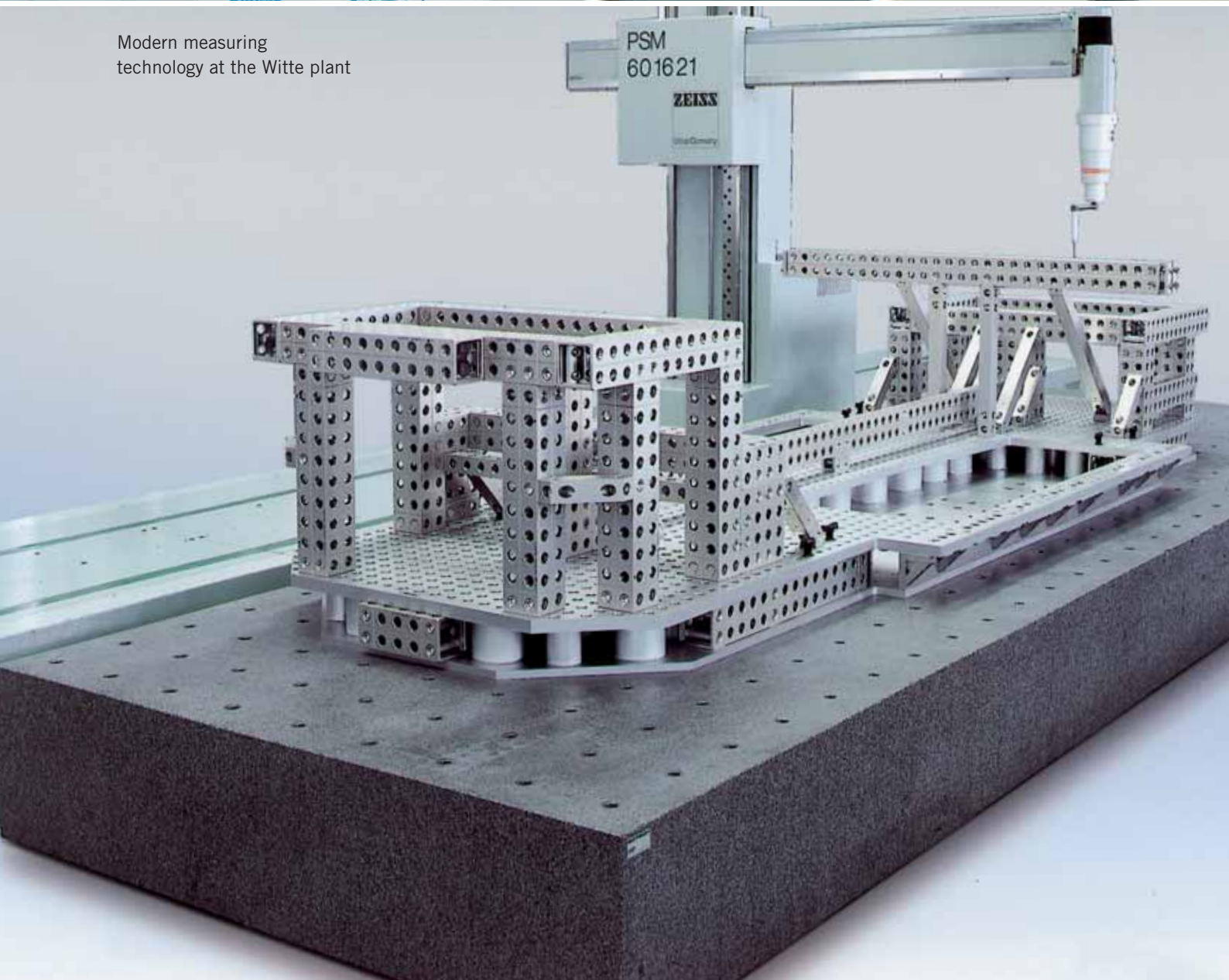

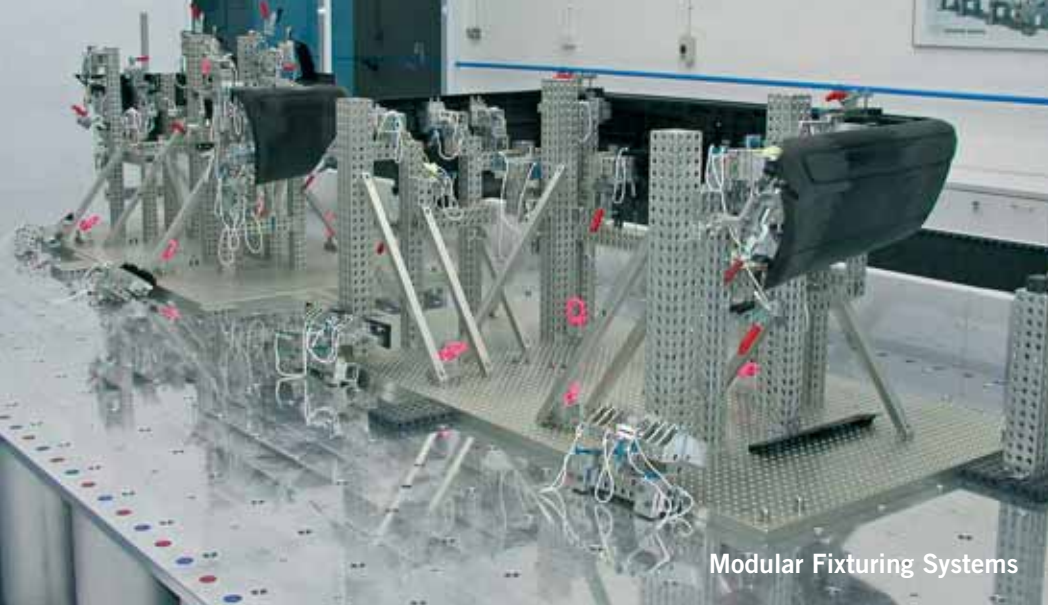

Modular Fixturing Systems



Premium Subcontracting



Vacuum Clamping Technology

Witte –
specialists for

**Modular
Fixturing Systems**

**Premium
Subcontracting**

**Vacuum Clamping
Technology**

Germany

Witte Barskamp KG

Horndorfer Weg 26-28

D-21354 Bleckede

Germany

Tel.: +49 (0) 58 54/89-0

Fax: +49 (0) 58 54/89-40

E-mail: info@witte-barskamp.de

www.witte-barskamp.de

Asia

Witte Far East Pte Ltd

20 Boon Lay Way

01 – 170

Singapore 609967

Singapore

Tel.: +65-6248 5961

Fax: +65-6898 4542

E-mail: info@witteasia.com

www.witteasia.com

USA & Canada

Witte LP

2220 Northmont Pkwy, Suite 250

Duluth, Georgia 30096

USA

Phone: +1 (770) 982 99 32

Fax: +1 (770) 982 99 28

E-mail: info@witteamerica.com

www.witteamerica.com

Mexico

Horst Witte de Mexico

S.A. de C.V.

Linco SC

2 Sur 1706, Col. El Carmen

Puebla, 72000

Mexico

Phone:

+52 222893-8210

E-mail: info@wittemexico.com

www.wittemexico.com

#19220 - Basic Sets english 07/2016

